

# TechBook



## Y series™

whatever the spa, this is your control system

Total Flexibility  
Total Compatibility  
Total Satisfaction





## Table of contents

Warnings.....	2
Introduction .....	3
Features .....	4
Overview	
- in.ye overview .....	5
- in.ye dimensions .....	5
- in.yt overview .....	6
- in.yt dimensions .....	6
Y Series installation	
- Floor installation procedure with optional guide plate .....	7
- Floor installation procedure without guide plate .....	7
- Wall installation procedure with optional wall mounting brackets .....	8
- Keypad installation .....	8
Y Series connections	
- Connecting the main keypad to the spa pack .....	9
- Heater connections .....	10
- High voltage accessory connections .....	11
Y Series wiring	
- Electrical wiring for North American models .....	16
- Electrical wiring for all models .....	16
- Electrical wiring: North American model .....	17
- Electrical wiring: in.ye-ce (European) .....	17
- Electrical wiring: in.yt-ce (European) .....	18
Power-up & breaker setting .....	19
Programming the Y Series .....	20
Typical output configurations .....	22
Output cables	
- Output cable opening size .....	25
- Output cable installation .....	25
- AMP pins and housings .....	26
Y Series field programming options	
- Custom configurations .....	27
Keypad overview	
- Function description .....	30
- Instructions .....	30
- Typical settings .....	32
Troubleshooting	
- Y Series error codes .....	33
- Hr error message .....	34
- Prr error message .....	34
- HL error message .....	35
- FLO error message .....	36
- OH error message .....	37
- UPL error message .....	37
- Pump 1 doesn't work .....	38
- Pump 2 or blower doesn't work .....	39
- Circulation pump doesn't work .....	40
- Ozonator doesn't work .....	41
- Nothing seems to work: North American models .....	42
- Nothing seems to work: European models .....	43
- Spa not heating .....	44
- Keypad doesn't seem to work .....	44
- GFCI/RCD trips .....	45
Step-by-step field replacement procedure	
- How to remove a spa pack from the spa piping .....	46
- How to replace the heater .....	49
- How to replace the main control board on in.ye .....	50
- How to replace the main control board on in.yt .....	51
- How to replace the upper extension board on the in.yt .....	52
Specifications	
- North American Models .....	54
- European Models .....	55



## Warnings

---



### WARNINGS:

Before installing or connecting the unit, please read the following.

---

- \* FOR UNITS FOR USE IN OTHER THAN SINGLE-FAMILY DWELLINGS, A CLEARLY LABELED EMERGENCY SWITCH SHALL BE PROVIDED AS PART OF THE INSTALLATION. THE SWITCH SHALL BE READILY ACCESSIBLE TO THE OCCUPANTS AND SHALL BE INSTALLED AT LEAST 5' (1.52 M) AWAY, ADJACENT TO, AND WITHIN SIGHT OF THE UNIT.
- \* ANY DAMAGED CABLE MUST BE IMMEDIATELY REPLACED.
- \* TURN POWER OFF BEFORE SERVICING OR MODIFYING ANY CABLE CONNECTIONS IN THIS UNIT.
- \* TO PREVENT ELECTRIC SHOCK HAZARD AND/OR WATER DAMAGE TO THIS CONTROL, ALL UNUSED BUSHING CONDUITS MUST BE PLUGGED WITH THE ATTACHED NIPPLE.
- \* THIS CONTROLLER MUST NOT BE INSTALLED IN PROXIMITY OF HIGHLY FLAMMABLE MATERIALS.
- \* LOW SUPPLY VOLTAGE OR IMPROPER WIRING MAY CAUSE DAMAGE TO THIS CONTROL SYSTEM. READ AND FOLLOW ALL WIRING INSTRUCTIONS WHEN CONNECTING TO POWER SUPPLY.
- \* THIS PACK CONTAINS NO USER SERVICEABLE PARTS. CONTACT AN AUTHORIZED SERVICE CENTER FOR SERVICE.
- \* ALL CONNECTIONS MUST BE MADE BY A QUALIFIED ELECTRICIAN IN ACCORDANCE WITH THE NATIONAL ELECTRICAL CODE AND ANY STATE, PROVINCIAL OR LOCAL ELECTRICAL CODE IN EFFECT AT THE TIME OF THE INSTALLATION.
- \* PRODUCT MUST BE DISPOSED OF SEPARATELY IN ACCORDANCE WITH LOCAL WASTE DISPOSAL LEGISLATION.

Aeware®, Gecko®, and their respective logos are Registered Trademarks of Gecko Alliance Group. In.yt™, in.ye™, in.keys™, in.touch™, in.k200™, in.k300™, in.k400™, in.k450™, in.k500™, in.k600™, K-19™, K-35™, K-8™, K-4, in.k800™, in.flo™, in.put™, in.seal™, in.link™, in.t.cip™, in.stik™, heat.wav™, Y Series™, and their respective logos are Trademarks of Gecko Alliance Group.

All other product or company names that may be mentioned in this publication are tradenames, trademarks or registered trademarks of their respective owners.



## Y Series

whatever the spa,  
this is your control system

The Y Series offers the kind of simplicity that makes for a genuine top-of-its-class product. It is the natural choice for anyone who wants an easy-to-understand multi-application solution.

You don't have to wonder about compatibility; instead, there's just the comforting certainty that when you invest in the Y Series, all spa configurations are supported. What's more, it also takes into account future compatibility, so you can have peace of mind knowing that you can enjoy your spa pack for years to come.



---

## Features

The Y Series systems boast a long list of technical features. Each of them contributes to bringing the most advanced solutions available to Y Series equipped spa owners:



**in.seal**  
watertight protection

In.seal provides an extra level of protection against water infiltration. Connectors and power box are designed to be watertight so that no water can be in direct contact with electrical components (IPX5).



**in.flo**  
dry-fire protection

A heater safety system located on the heat.wav heater with an all-electronic dry-fire protection.



**in.stik**  
automated software upload

The in.stik is a pen drive with an in.link connector very similar to a USB memory stick. It connects to the spa pack and contains data to program or configure its system. The system executes the data upload automatically.



**in.t.cip**  
water temperature algorithm

In.t.cip is an intelligent water temperature refresh algorithm that calculates optimal time to start pumps and get water temperature readings. In.t.cip continuously readjusts the heater start time.



**in.touch**  
you're always in touch with your relaxation

All Y Series packs support the in.touch WiFi interface, allowing you to use your favorite iOS device to communicate with your spa.



**in.link**  
ingenious plugs and connectors

The Y Series is only compatible with the low-voltage family of in.link connectors, such as those used by keypads and similar low-voltage accessories.



# Overview

## in.ye overview

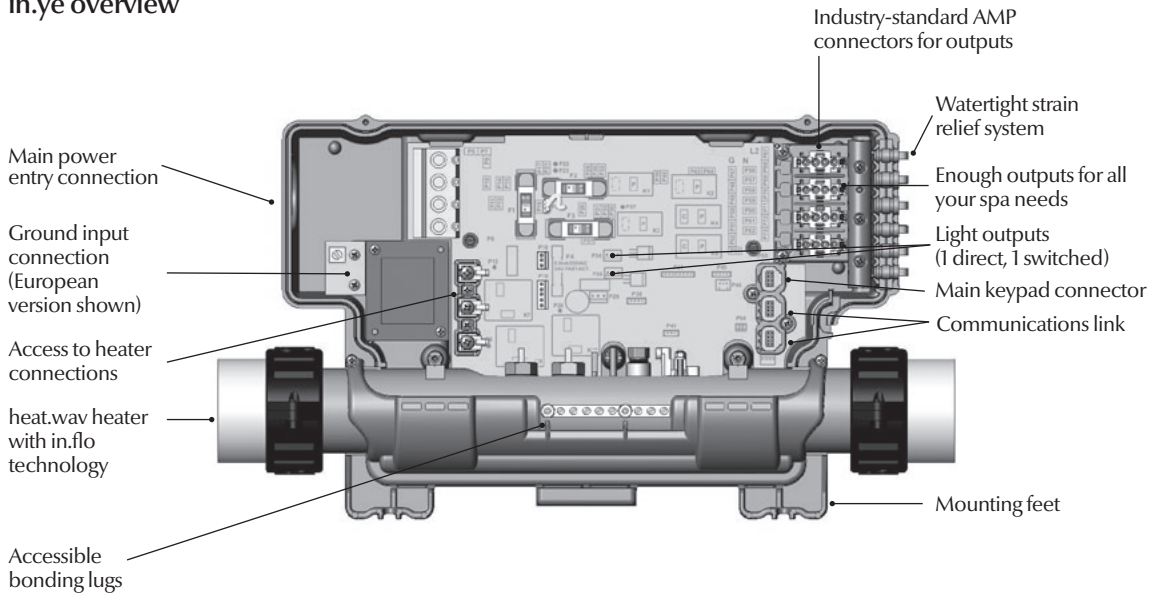

## in.ye dimensions

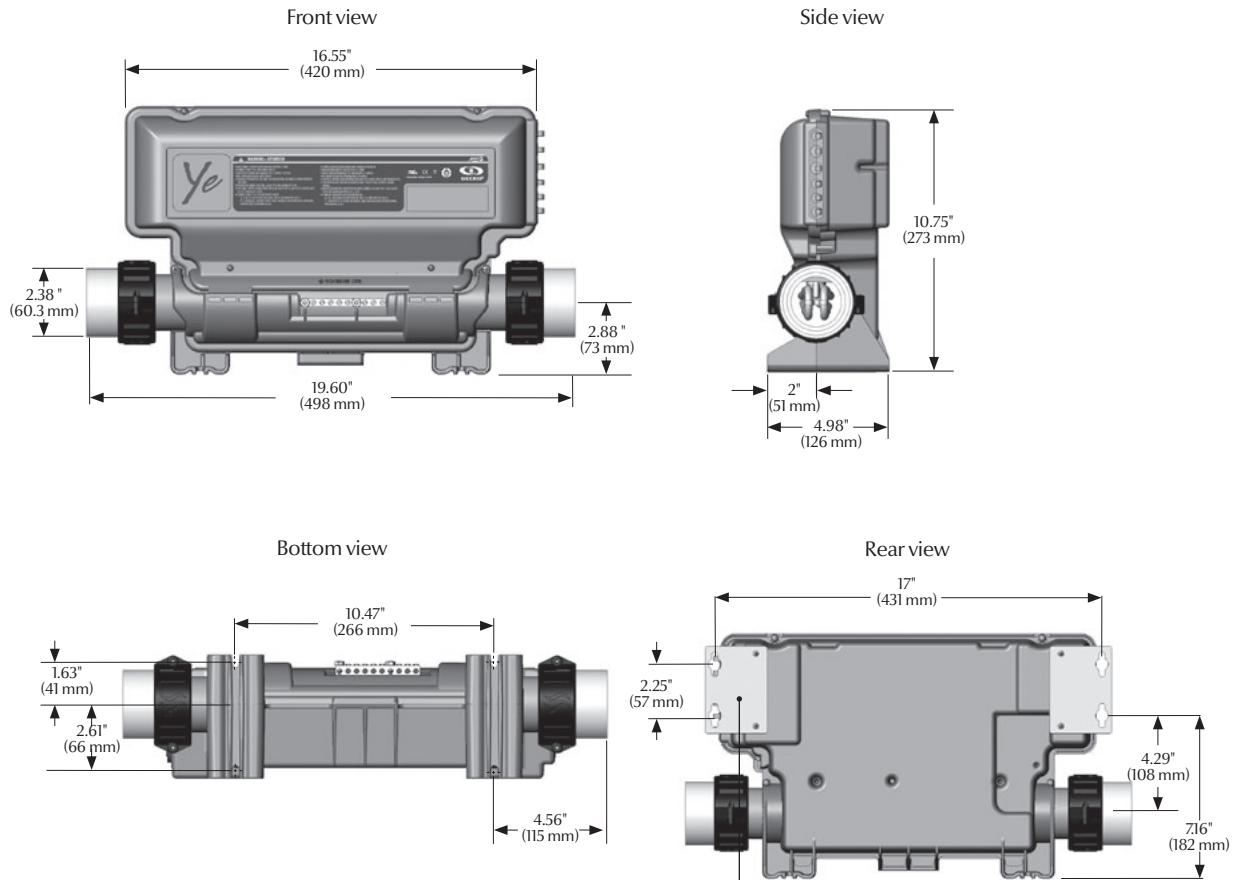

Note: Shown with optional wall mouting brackets (see Installation).



# Overview

## in.yt overview

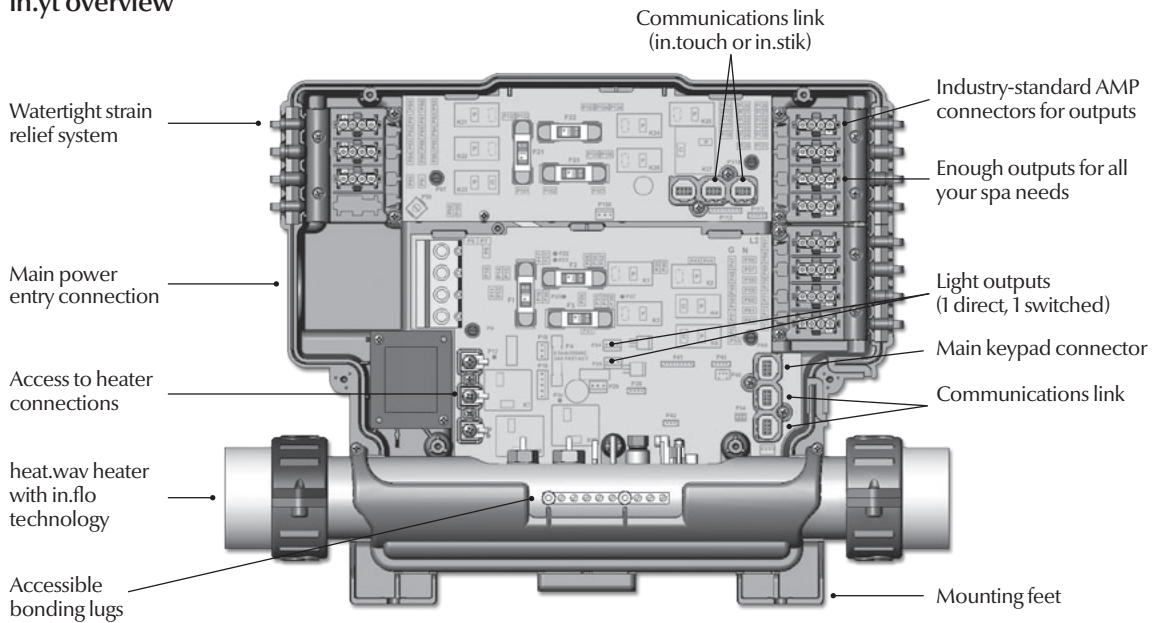

## in.yt dimensions

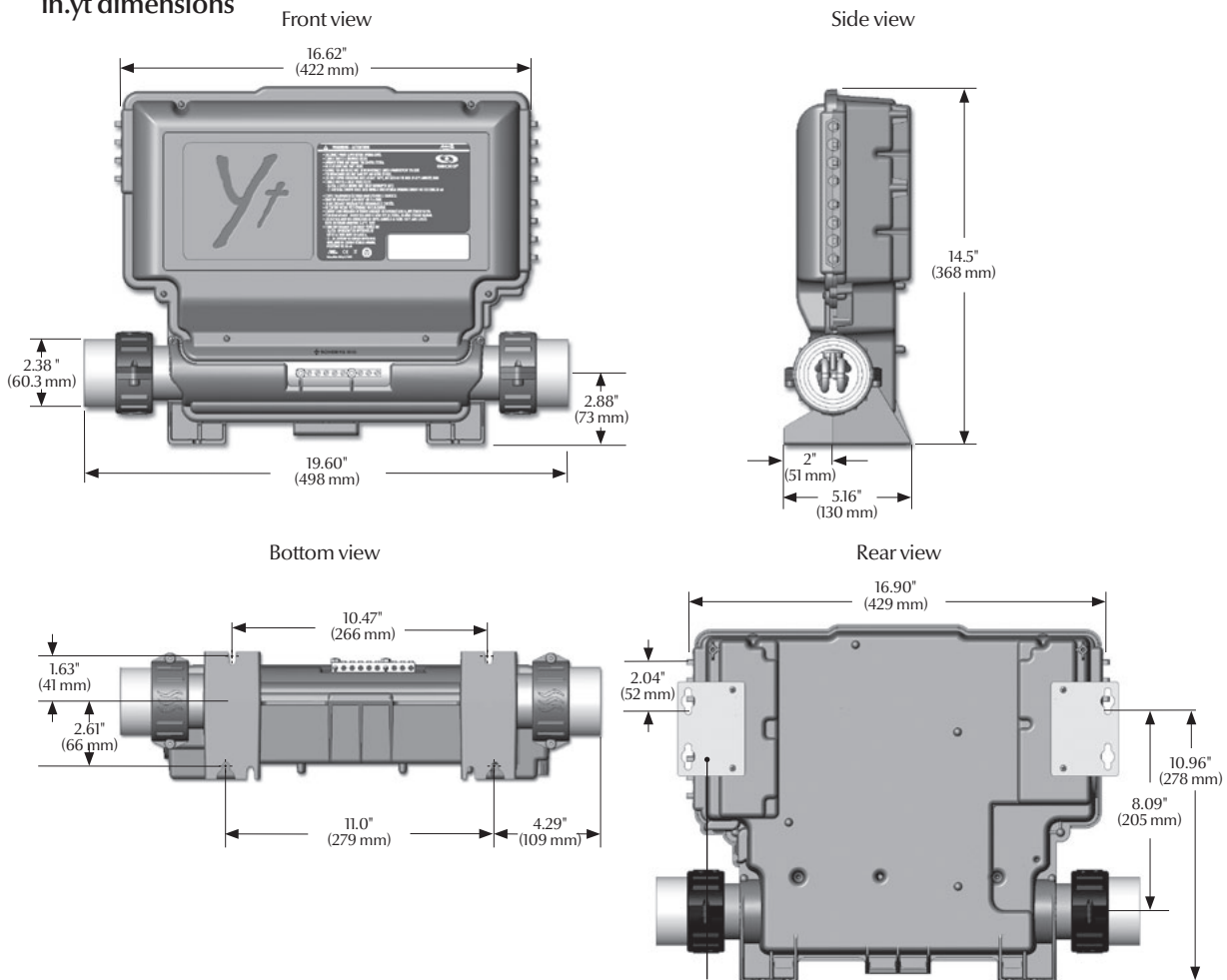

Note: Shown with optional wall mounting brackets (see Installation).



## Y Series installation

### Important! Read before starting:

Please note that countersunk screws should not be used as they can damage the power box support. The heat.way heating element must be installed in the return circuit of the main pump (pressure side).

#### Warning!

Beware the application of some products commonly used against corrosion (such as WD-40 family products) as they could damage the power box, due to a negative chemical reaction between some industrial oils and its plastic enclosure. Any other materials which may come in contact with the enclosure must be carefully evaluated under end use conditions for compatibility.

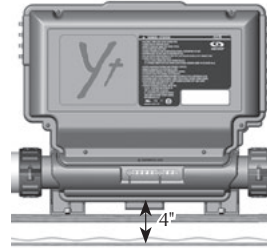

*Note: The spa pack must be installed at least 4" (100 mm) above potential flood level. If floor is on ground level, pack should be raised at least 4" (100 mm).*

### Floor installation procedure with optional guide plate

#### Material:

- 4- # 10 screws with round, truss or pan head.
- 4- washers 1/2" OD x 1/16" thickness (12 mm OD x 1.5 mm)
- Guide plate

*Part numbers:  
9917-102148 (in.ye guide plate)  
9917-100873 (in.yt guide plate)*

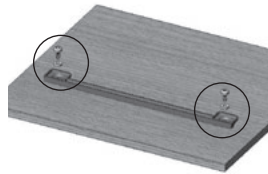

Select the location on the floor for spa pack and firmly attach guide plate to wooden base with 2 screws backed by 2 washers.

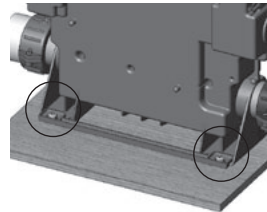

Slide back side of the unit's feet into the guide plate. It should easily slide into place.

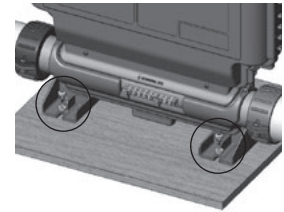

Now firmly attach unit to wooden base by using the remaining 2 screws backed by 2 washers to attach the front feet.

### Floor installation procedure without guide plate

- The following material is recommended:**
- 4- # 10 screws with round, truss or pan head.
  - 4- washers 1/2" OD x 1/16" thickness (12 mm OD x 1.5 mm)

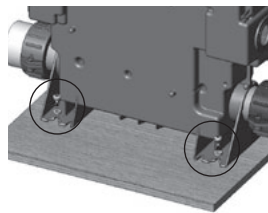

Select the most appropriate location on the floor for the spa pack and firmly attach the 2 rear feet to the wooden base using 2 screws backed by 2 washers.

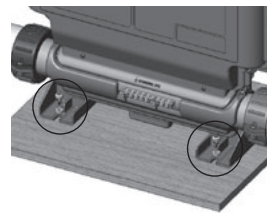

Now firmly attach the front feet of the pack to the wooden floor using 2 more screws backed by 2 washers.





## Y Series installation

### Wall installation procedure with optional wall mounting brackets

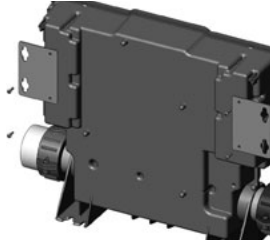

Install mounting brackets on both sides of rear of unit, using the screws provided with the bracket.

Torque screws to 13 in.lb max (1.49 N.m).

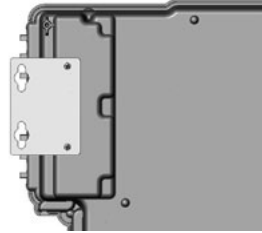

The following material is recommended:

4- # 10 screws of appropriate length with round, truss or pan head.

4- washers 1/2" OD x 1/16" thickness (12 mm OD x 1.5 mm)

Use 2 standard 2" x 4" or 2" x 6" wall studs, spaced on 17-inch (431 mm) centers to affix the spa pack.

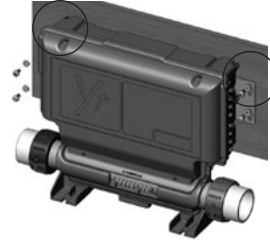

Firmly attach, one at a time, upper mounting holes on each side of the spa pack with 2 screws backed by 2 washers.

Firmly attach lower mounting holes on each side of the pack with the 2 remaining screws and 2 washers. Lower mounting holes are 2" (51 mm) below upper holes.

*Part number:  
9920-101474 (100 bracket  
bundle with 200 screws)*

### Keypad installation

See the techbook for your specific keypad model for installation details and drilling template.

## Y Series connections

### Connecting the main keypad to the spa pack

To connect the keypad, remove the cover, then insert the in.link connector into the appropriate keypad connector (as illustrated). Route the cable through one of the molded strain relief channels on the bottom right side of the spa pack (as illustrated). Fill the remaining space with the foam gaskets supplied. Don't forget to replace the cover and all screws (torque to 8 in.lb max [0.9 N.m]).

*Note: always shut power down before connecting an accessory to the in.ye or in.yt.*

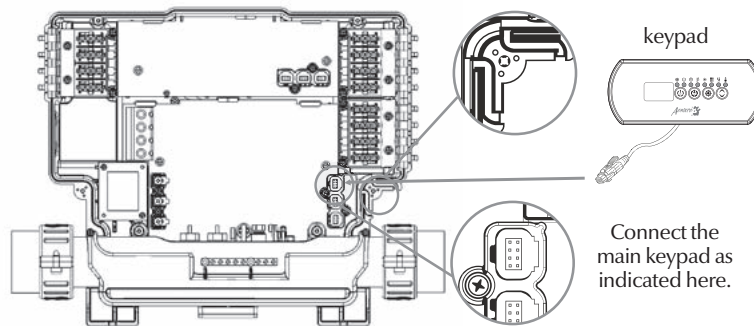



## Y Series connections

### Heater connections

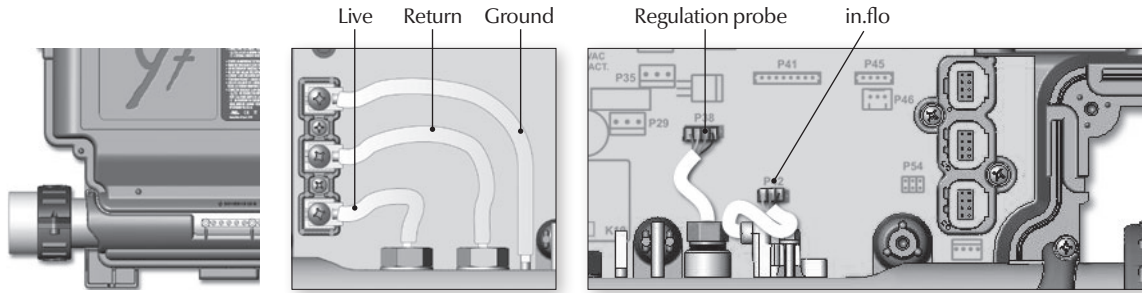

### heat.wav heater

All Y Series systems come with a high performance heat.wav heater. With no pressure switch, it features in.flo integrated dry-fire protection.

The heat.wav heater is factory configured for 240 V / 4 kW, but it can be converted to a dedicated 120 V / 1 kW by simply adding a cable connection. (120 V conversion is available on North American in.ye-3 models only).

heat.wav specification summary:

- Supports 120 V or 240 V
- Protected by external breaker (not fused)\*
- Incoloy® heater element
- Optional 5.5 kW, 240 V heater is available.

\*Note: European models are 230-240 V only, and are fuse protected

Part numbers:  
9917-101959 (cable for conversion)  
9920-101449 (5.5 kW heat.wav heater)

All heater connections are accessible when the cover is removed. Connections include the in.flo dry-fire protection, hi-limit/regulation probe connectors, power and ground cable connections.

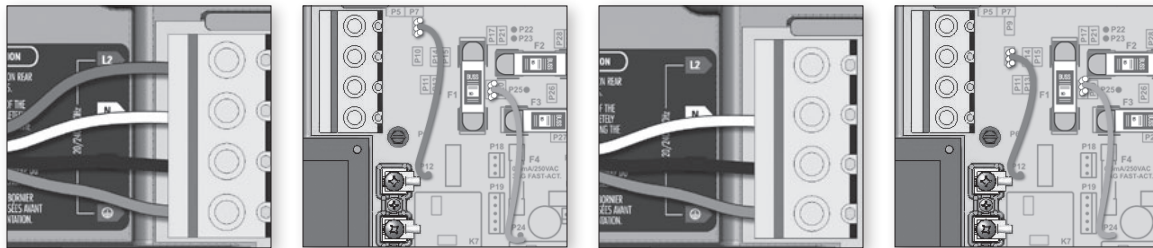

### Connections for all 240 V heaters (North American installations only)

BROWN wire must be correctly and completely connected between P12 and P9.

For early North American version installations  
the YELLOW wire must be between P25 and P20.  
the ORANGE wire must be between P24 and P16

### Connections for all 120 V heaters

BROWN wire must be correctly and completely connected between P12 and P10.

Note: To convert model to a 120 V system, the white (common) accessory wire must be moved. See wiring diagram for details.



# Y Series connections

## High voltage accessory connections

Two options are available with Y Series spa packs for connecting high voltage accessories: 0.250" quick-connect terminals, or AMP pins and housings.

### Connection high voltage accessories: in.ye

These tabs require high-voltage accessories to have straight, non-insulated, female quick-connect terminals for all connections, including ground. Depending on where the connections are made on the in.ye pack PCB, 120 V and 240 V accessories are supported. Refer to the following tables for correct connections. Note that all female terminals must be correctly and completely seated on the PCB tab for proper current ratings.

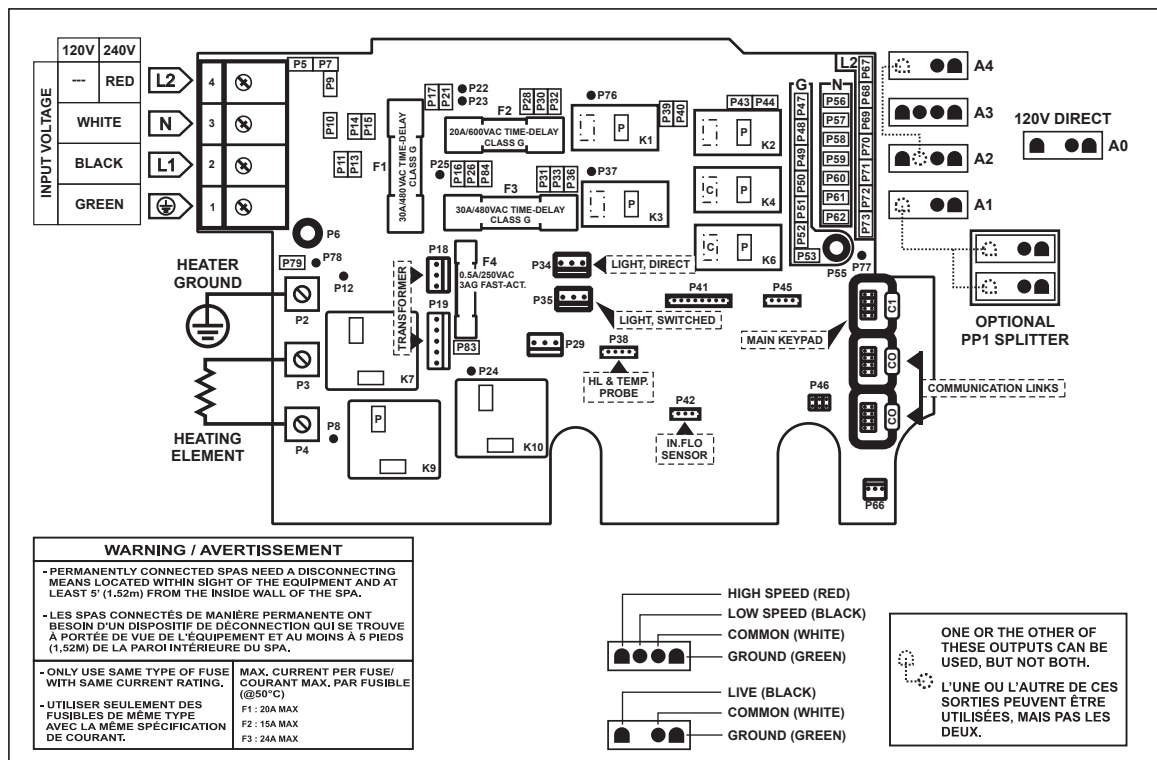

Direct output 1 (in.ye-5 only) (floating connector)		
Voltage	120 V	240 V
Green / ground	P47	P47
Black / line	P32	P32
White / common	P56	P67

Pump 1 (A3)		
Voltage	120 V	240 V
Green / ground	P49	P49
Black / low speed	K2-P	K2-P
White / common	P58	P69

Pump 3 (A4) (in.yt-5 only)		
Voltage	120 V	240 V
Green / ground	P48	P48
Black / low speed	K6-P	K6-P
White / common	P57	P68

Ozonator* (A1)		
Voltage	120 V	240 V
Green / ground	P52	P52
Black / line	K1-P	K1-P
White / common	P61	P72

Pump 2 (A2)		
Voltage	120 V	240 V
Green / ground	P51	P51
Black / low speed	K6-P	K6-P
Red / high-speed	K3-P	K3-P
White / common	P60	P71

Circ. pump* (A1)		
Voltage	120 V	240 V
Green / ground	P52	P52
Black / line	K1-P	K1-P
White / common	P61	P72

Blower (A4) (in.ye-5 only)		
Voltage	120 V	240 V
Green / ground	P48	P48
Black / line	K6-P	K6-P
White / common	P57	P68

Light (12 V AC, 1A Max.)		
Voltage		
Always on		P34
Relay		P35

\* Ozonator and circ pump can be combined on the same output via the optional splitter PPI.

This table shows typical connections. OEMs may have a different connection scheme.



# Y Series connections

## Connection high voltage accessories: in.yt

These tabs require high-voltage accessories to have straight, non-insulated, female quick-connect terminals for all connections, including ground. Depending on where the connections are made on the spa pack PCB, 120 V and 240 V accessories are supported. Refer to the following tables for correct connections. Note that all female terminals must be correctly and completely seated on the PCB tab for proper current ratings.

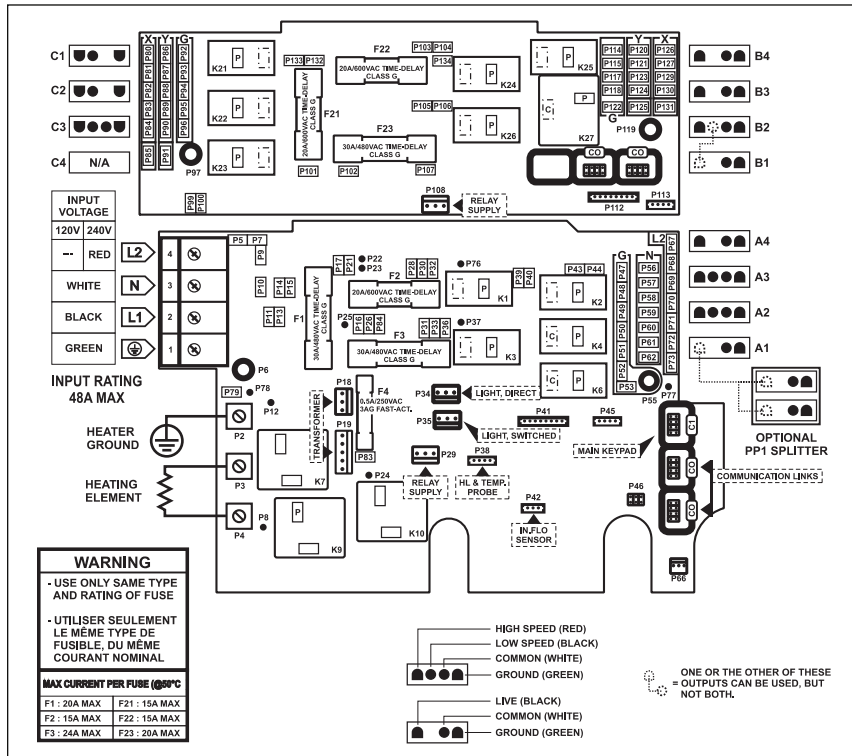

Direct output 1 (A4)		
Voltage	120 V	240 V
Green / ground	P47	P47
Black / line	P32	P32
White / common	P56	P67

Direct output 2 (C1) (in.yt only)		
Voltage	120 V	240 V
Green / ground	P92	P92
Black / line	P133	P133
White / common	P86	P80

Auxiliary (B1) (in.yt-12 only)		
Voltage	120 V	240 V
Green / ground	P118	P118
Black / line	K26-P	K26-P
White / common	P124	P130

Pump 1 (A3)		
Voltage	120 V	240 V
Green / ground	P49	P49
Black / low speed	K2-P	K2-P
Red / high-speed	K4-P	K4-P
White / common	P58	P69

Pump 3 (C3) (in.yt-7 and in.yt-12)		
Voltage	120 V	240 V
Green / ground	P94	P94
Black / low speed	K22-P	K22-P
Red / high-speed	K21-P	K21-P
White / common	P88	P82

Pump 5 (B3) (in.yt-12 only)		
Voltage	120 V	240 V
Green / ground	P115	P115
Black / line	K24-P	K24-P
White / common	P121	P127

Ozonator (A1)		
Voltage	120 V	240 V
Green / ground	P52	P52
Black / line	K1-P	K1-P
White / common	P61	P72

Pump 2 (A2)		
Voltage	120 V	240 V
Green / ground	P51	P51
Black / low speed	K6-P	K6-P
Red / high-speed	K3-P	K3-P
White / common	P60	P71

Pump 4 (B2) (in.yt-12 only)		
Voltage	120 V	240 V
Green / ground	P118	P118
Black / low speed	K26-P	K26-P
Red / high-speed	K27-P	K27-P
White / common	P123	P129

Circ. pump (C2) (in.yt-7 and in.yt-12)		
Voltage	120 V	240 V
Green / ground	P93	P93
Black / line	K23-P	K23-P
White / common	P87	P81

Blower (B4) (in.yt-12 only)		
Voltage	120 V	240 V
Green / ground	P114	P114
Black / line	K25-P	K25-P
White / common	P120	P126

Light (12 V AC, 1A Max.)		
Voltage	120 V	240 V
Always on	P34	
Relay	P35	

This table shows typical connections. OEMs may have a different connection scheme.



## Y Series connections

### Connection high voltage accessories: in.ye-ce (European)

These tabs require high-voltage accessories to have straight, non-insulated, female quick-connect terminals for all connections, including ground. On -ce packs, only 230V accessories are supported. Refer to the following tables for correct connections. Note that all female terminals must be correctly and completely seated on the PCB tab for proper current ratings.

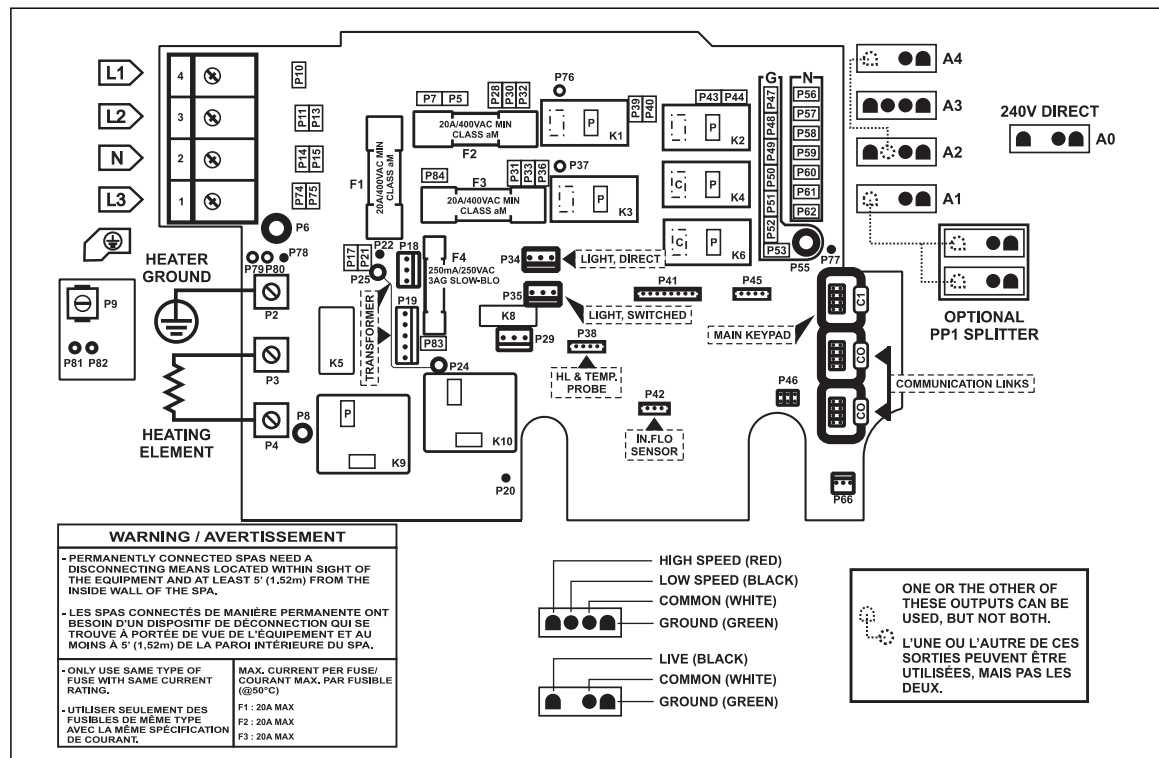

Direct output 1 (in.ye-5 ce only) (floating connector)	Pump 1 (A3)	Pump 3 (A4) (in.yt-5 ce only)	Ozonator* (A1)
Voltage	Voltage	Voltage	Voltage
Green / ground P47	Green / ground P49	Green / ground P48	Green / ground P52
Black / line P32	Black / low speed K2-P	Black / low speed K6-P	Black / line K4-P
White / common P56	Red / high-speed K1-P	White / common P57	White / common P62
	White / common P59		

Pump 2 (A2)	Circ. pump* (A1)	Blower (A4) (in.ye-5 ce only)	Light (12 V AC, 1A Max.)
Voltage	Voltage	Voltage	Voltage
Green / ground P51	Green / ground P52	Green / ground P48	Always on P34
Black / low speed K6-P	Black / line K4-P	Black / line K6-P	Relay P35
Red / high-speed K3-P	White / common P62	White / common P57	
White / common P60			

\* Ozonator and circ pump can be combined on the same output via the optional splitter PPI.

This table shows typical connections. OEMs may have a different connection scheme.



# Y Series connections

## Connection high voltage accessories: in.yt-ce (European)

These tabs require high-voltage accessories to have straight, non-insulated, female quick-connect terminals for all connections, including ground. On -ce packs, only 230V accessories are supported. Refer to the following tables for correct connections. Note that all female terminals must be correctly and completely seated on the PCB tab for proper current ratings.

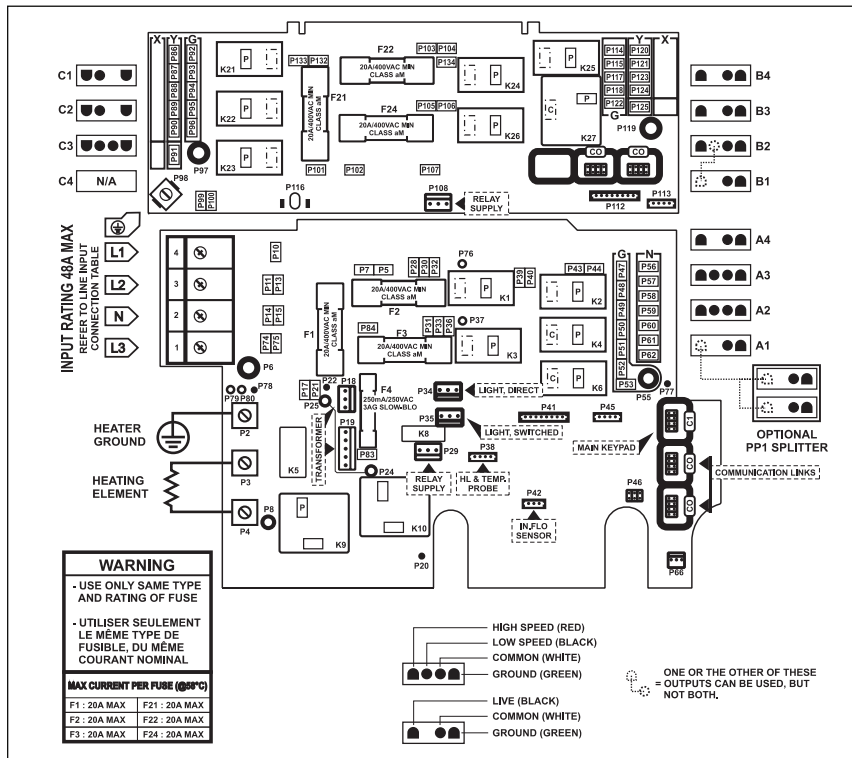

Direct output 1 (A4)	
Voltage 230 V	
Green / ground	P47
Black / line	P32
White / common	P56

Direct output 2 (C1) (in.yt only)	
Voltage 230 V	
Green / ground	P92
Black / line	P133
White / common	P86

Auxiliary (B1) (in.yt-12 only)	
Voltage 230 V	
Green / ground	P118
Black / line	K26-P
White / common	P124

Pump 1 (A3)	
Voltage 230 V	
Green / ground	P49
Black / low speed	K2-P
Red / high-speed	K1-P
White / common	P58

Pump 3 (C3) (in.yt-7 and in.yt-12)	
Voltage 230 V	
Green / ground	P94
Black / low speed	K22-P
Red / high-speed	K21-P
White / common	P88

Pump 5 (B3) (in.yt-12 only)	
Voltage 230 V	
Green / ground	P115
Black / line	K24-P
White / common	P121

Ozonator (A1)	
Voltage 230 V	
Green / ground	P52
Black / line	K4-P
White / common	P61

Pump 2 (A2)	
Voltage 230 V	
Green / ground	P51
Black / low speed	K6-P
Red / high-speed	K3-P
White / common	P60

Pump 4 (B2) (in.yt-12 only)	
Voltage 230 V	
Green / ground	P118
Black / low speed	K26-P
Red / high-speed	K27-P
White / common	P123

Circ. pump (C2) (in.yt-7 and in.yt-12)	
Voltage 230 V	
Green / ground	P93
Black / line	K23-P
White / common	P87

Blower (B4) (in.yt-12 only)	
Voltage 230 V	
Green / ground	P114
Black / line	K25-P
White / common	P120

Light (12 V AC, 1A Max.)	
Voltage	
Always on	P34
Relay	P35

This table shows typical connections. OEMs may have a different connection scheme.



## Y Series connections

### Connection high voltage accessories: in.yt-7-ce (European), part # 0611-221009 only

These tabs require high-voltage accessories to have straight, non-insulated, female quick-connect terminals for all connections, including ground. On -ce packs, only 230V accessories are supported. Refer to the following tables for correct connections. Note that all female terminals must be correctly and completely seated on the PCB tab for proper current ratings.

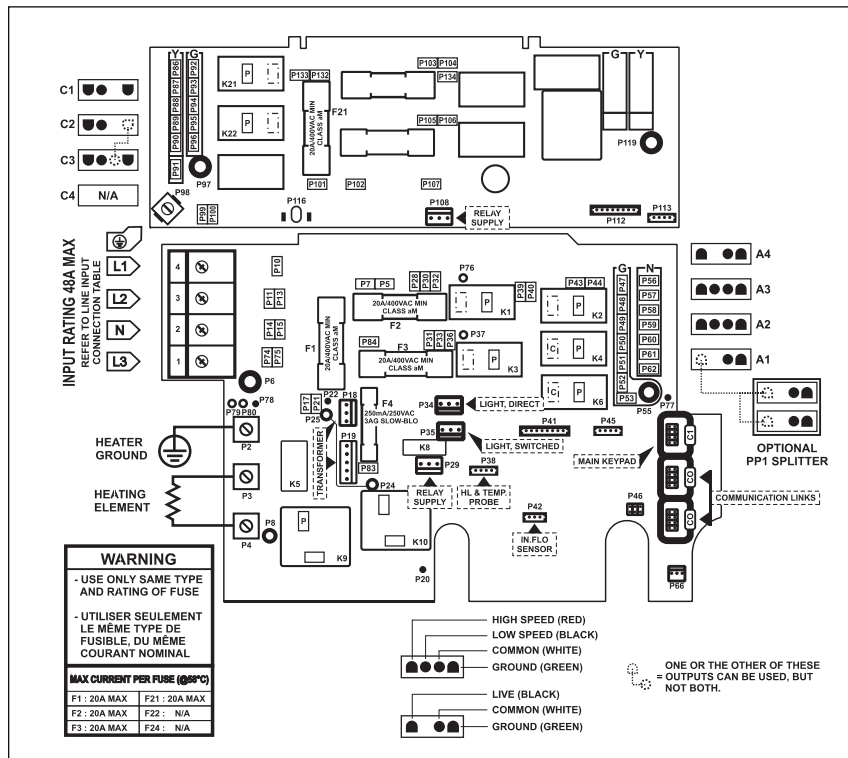

Pump 1 (A3)	Pump 3 (A1)	Circ. pump (C2)	Ozonator (A4)
Voltage 230 V	Voltage 230 V	Voltage 230 V	Voltage 230 V
Green / ground P49	Green / ground P52	Green / ground P93	Green / ground P47
Black / low speed K2-P	Black / line K4-P	Black / line K22-P	Black / line K6-P
Red / high-speed K1-P	White / common P61	White / common P87	White / common P56
White / common P58			

Pump 2 (A2)	Pump 4 (C3) (in.yt-7)	Light (12 V AC, 1A Max.)	Direct output (C1)
Voltage 230 V	Voltage 230 V	Voltage	Voltage 230 V
Green / ground P51	Green / ground P94	Always on P34	Green / ground P92
Black / low speed K6-P	Black / low speed K22-P	Relay P35	Black / line P133
Red / high-speed K3-P	Red / high-speed K21-P		White / common P86
White / common P60	White / common P88		

This table shows typical connections. Individual configuration will depend on the Low Level selected.





## Y Series wiring

### Electrical wiring for North American models

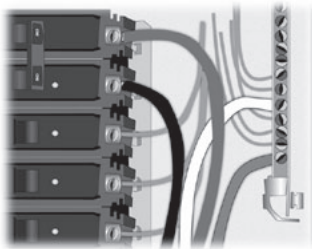
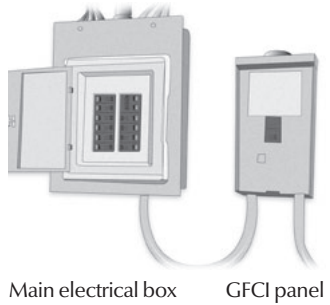

#### Warning!

For units for use in other than single-family dwellings, a clearly labeled emergency switch shall be provided as part of the installation. The switch shall be readily accessible to the occupants and shall be installed at least 5' (1.52 m) away, adjacent to, and within sight of the unit.

-----  
This product must always be connected to a circuit protected by a ground fault interrupter.

Proper wiring of the electrical service box, GFCI and Y Series terminal block is essential!

Check your electrical code for local regulations. Only copper wire should be used, never aluminum.



#### Disposal of the product

The appliance (or the product) must be disposed of separately in accordance with the local waste disposal legislation in force.

### Electrical wiring for all models

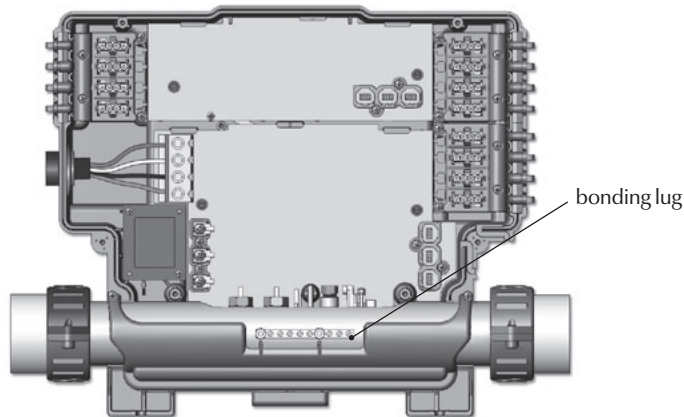

To install the wiring for the Y Series spa control, you'll need a Phillips screwdriver and a flat screwdriver.

Loosen the screws of the spa pack cover and remove it. Remove 5 1/2" (142 mm) of cable insulation. Strip away 1" (25 mm) of each wire insulation. Pull the cable through the cutout of the box and secure it with a strain relief (1" NPT strain relief; hole diameter: 1.335" [33.9 mm]).

(For CE use an IEC certified plastic bushing that will maintain the IPX5 rating.)

Make sure that only the uncut sheathing is clamped at this opening. Make sure that the terminal block case clamps are lowered before inserting wires.

Push the color-coded wires into the terminals as indicated on the sticker and use the flat screwdriver to tighten the screws on the terminals.

After making sure wire connections are secure, push them back into the box and replace the cover. Tighten the screws of the spa pack cover. Do not over tighten cover screws (torque to 8in.lb max [0.9 N.m]).

Connect the bonding conductor to the bonding lug on the front of the Y Series spa pack (a grounded electrode conductor shall be used to connect the equipment grounding conductors).



## Y Series wiring

### Electrical wiring: North American model

Refer to wiring diagram in the enclosure box lid for more information.

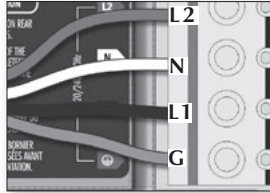

For 240 V (4 wires)

Correct wiring of the electrical service box, GFCI, and pack terminal block is essential. Call an electrician if necessary.

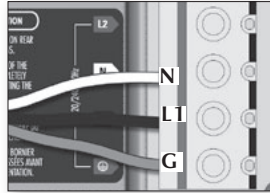

For 120 V (\*3 wires)

\*If connected to a 3 wire system, no 240 V component will work.

*Note:* To convert model to a 120 V system, the white (common) accessory wire must be moved. See wiring diagram for details.

### Electrical wiring: in.ye-ce (European)

Refer to wiring diagram in the enclosure box lid for more information.

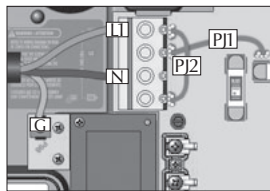

1-phase  
L1 current returns through neutral  
Connect P1 between P7 and P13. Connect P2 between P10 and P74.

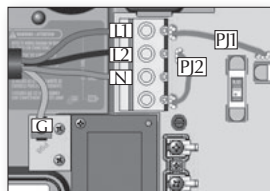

2-phase  
with single neutral  
L1+L2 currents return through neutral  
Connect P1 between P7 and P10. Connect P2 between P13 and P74.

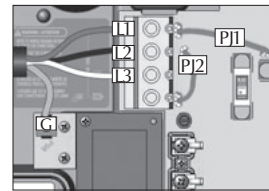

2-phase used from 3-phase  
Delta – no neutral  
Use 2-phase setting  
L1+L2 currents return through L3  
Connect P1 between P7 and P10. Connect P2 between P13 and P74.

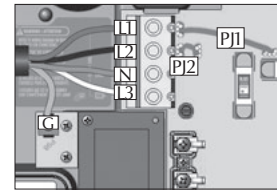

3-phase  
with single neutral  
L1, L2+L3 currents return through neutral  
Connect P1 between P7 and P10. Connect P2 between P11 and P13.

#### in.ye.ce 230 V or 230/400 V

Correct wiring of the electrical service box, RCD, and pack terminal block is essential!  
Call an electrician if necessary.

#### Warning!

in.ye.ce models must always be connected to a circuit protected by a Residual-Current Device (RCD) having a rated operating residual-current not exceeding 30 mA.



## Y Series wiring

### Electrical wiring: in.yt-ce (European)

Refer to wiring diagram in the enclosure box lid for more information.

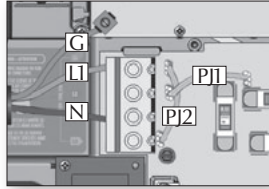

**1-phase**  
L1 current returns through neutral  
Connect P1 between P7 and P13. Connect P2 between P10 and P74.

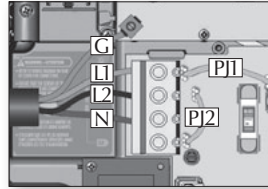

**2-phase with single neutral**  
L1+L2 currents return through neutral  
Connect P1 between P7 and P10. Connect P2 between P13 and P74.

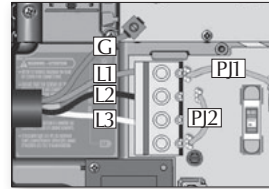

**2-phase used from 3-phase**  
Delta – no neutral  
*Use 2-phase setting*  
L1+L2 currents return through L3  
Connect P1 between P7 and P10. Connect P2 between P13 and P74.

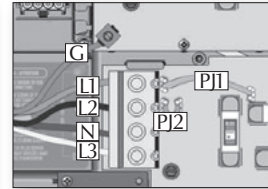

**3-phase with single neutral**  
L1, L2+L3 currents return through neutral  
Connect P1 between P7 and P10. Connect P2 between P11 and P13.

### in.yt.ce 230 V or 230/400 V

Correct wiring of the electrical service box, RCD, and pack terminal block is essential!  
Call an electrician if necessary.

### **Warning!**

in.yt.ce models must always be connected to a circuit protected by a Residual-Current Device (RCD) having a rated operating residual-current not exceeding 30 mA.

## Power-up & breaker setting



### IMPORTANT! Read before starting

Turn off the breaker.

Make sure all accessories are linked to the bonding connector and connected to pack.

A minimum flow rate of 18 GPM is required. Make sure that all valves are open in the spa plumbing and that you have good water flow circulation from the primary pump into the heater.

Turn on the breaker.

### in.flo dry-fire protection

At power up, the in.flo detector performs a flow check through the following process:

Pump 1 or circulation pump starts for 2 minutes. The display will show "---" during the check flow process. After 2 minutes the system validates proper water flow.

In case of failure, the system tries again. The water temperature is shown on the keypad display. Once the water has reached the set point value plus 0.8°F the heater is turned off.

### Boot up display sequence (Each parameter is displayed for 2 seconds)



Lamp test

All the segments and LEDs light up.



Software number

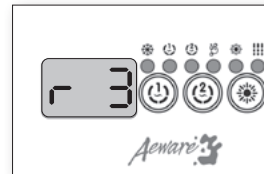

Software revision

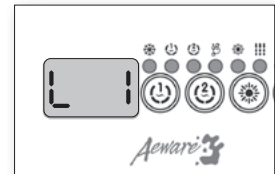

Low-level selection

Low-level selected from low-level menu

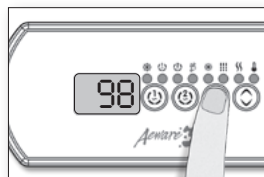

It's important to specify the current rating of the GFCI used to ensure safe and efficient current management (and reduce nuisance GFCI trippings).

Press and hold the **Prog** button until you access the breaker setting menu (programming menu will appear first).

Note: if the keypad in use does not have the **Prog** key, use the **Light** key instead.

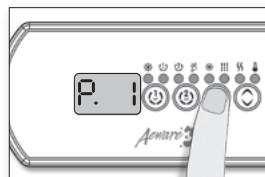

Choose the number of phases supplying your spa. Use the **Up/Down** key to choose the desired value and press the **Program** or **light** key to confirm the selection. You can choose between 1, 2 or 3 phases.

#### Number of phase selection

UL	Menu not available
CE	1, 2 or 3
UL Swim*	1 or 2
CE Swim*	1, 2 or 3

\* See Swim Spa manual for details.



The values displayed by the system correspond to 0.8 of the maximum amperage capacity of the GFCI.

Use the **Up/Down** buttons to select the desired value.

The value can typically be modified from 10 to 48 A.

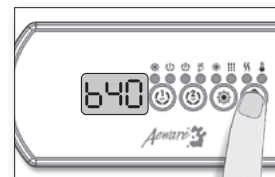

Press the **Prog** button to set breaker rating.

This table shows typical settings of b for different GFCI ratings. Select the one that matches your breaker.

GFCI	b
60 A	48 A
50 A	40 A
40 A	32 A
30 A	24 A
20 A	16 A

Note: Every OEM has its own preset configurations.



## Programming the Y Series

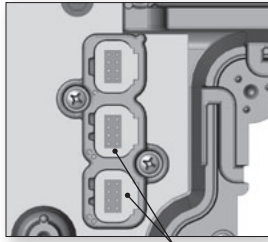

communications port

### Programming the Y Series using the in.stik

Follow these simple steps to upload new pre-determined low-level program configurations into the spa pack.

Shut electrical power off.

Remove the cover to access the low-voltage in.link connectors inside, connect the in.stik to the communications port (see figure), and then re-apply power to pack.

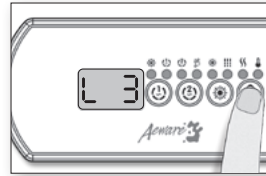
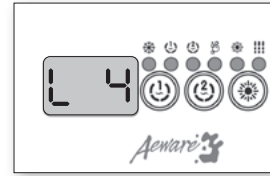

At power-up the spa pack will upload all the different configurations from the in.stik memory.

The unit will then enter the low-level configuration menu.

The keypad display will show Lxx where "xx" represents the previous configuration number registered in the system.

Use the Up/Down key to choose the new desired low-level configuration number.

Press the **Prog** key to confirm the selected configuration.

If the **Prog** key is not pressed within 25 seconds, the unit will exit this menu without changing any settings.

*Note: If the keypad in use does not have the **Prog** key, use **Light** key instead.*

*Note: When programming is finished, do not forget to turn power off, remove the in.stik, and re-install the pack's cover.*

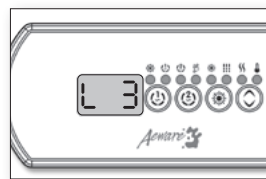
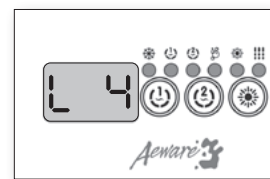
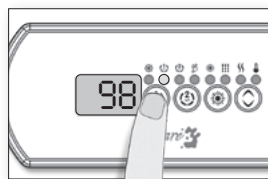

### Programming the Y Series using the keypad

Although every Y Series spa pack is factory set, in certain cases when servicing or replacing a new unit in the field, it may be necessary to set a new pre-determined low-level program configuration into the spa pack.

Follow these simple steps to re-enter the low-level programming menu using the keypad:

Press and hold the **Pump 1** key for 30 seconds.

The keypad display will show Lxx where "xx" represents the previous configuration number registered in the system.

Use the **Up/Down** key to choose the new desired low-level configuration number and press the **Program** key to confirm the selected configuration.

If the **Program** key is not pressed within 25 seconds, the unit will exit this menu without changing any settings.

*Note: If the keypad in use does not have the **Program** key, use the **Light** key instead.*



---

## Programming the Y Series

Please refer to the Quick Start Card for your model to set the proper low level and connector location. Contact your OEM for specific configurations.

Model	Quick Start Card Number
in.ye-3	9919-101202
in.ye-3-ce	9919-101203
in.ye-5	9919-101192
in.ye-5-ce	9919-101193
in.yt-7	9919-101204
in.yt-7-ce	9919-101205
in.yt-12	9919-101206



## Typical output configurations

Individual configuration will depend on the low level selected. Refer to low level table and wiring diagram.

in.ye-3

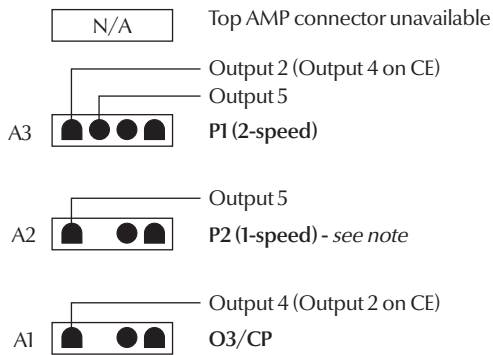
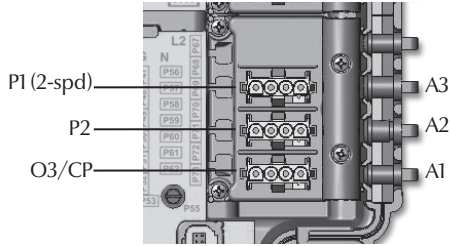

in.ye-5

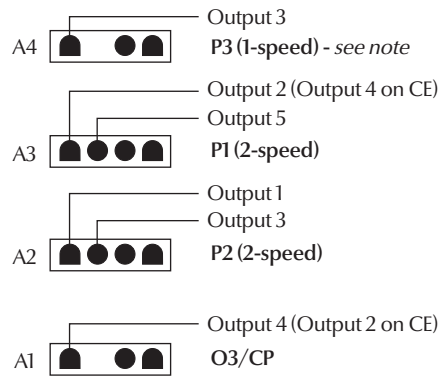
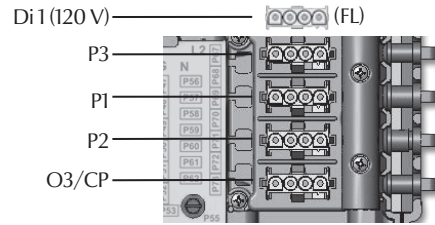

Note: If P2 is used, P1L cannot be used.

Note: If P3 is used, P2L cannot be used.

in.yt-7

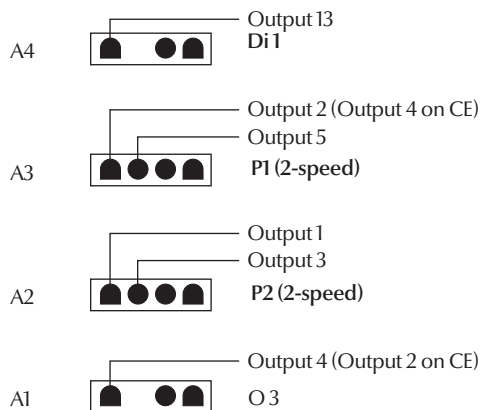
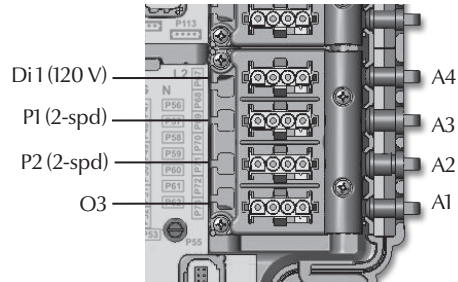
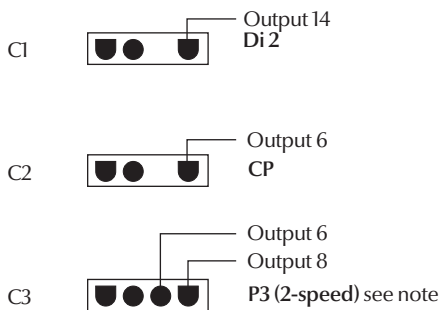
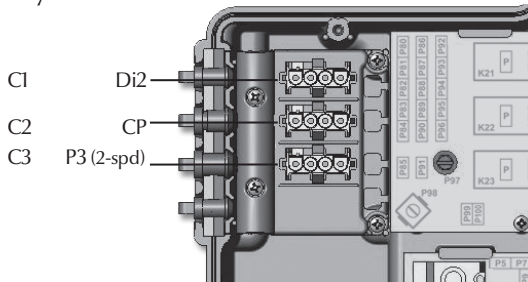

Note: If P3, 2 speed is used, CP must be on output 4 with the ozonator.



## Typical output configurations

in.yt-7, part # 0611-221009 only

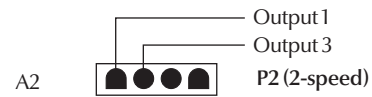
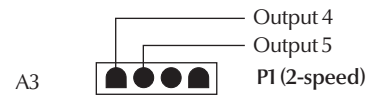
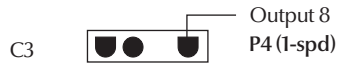
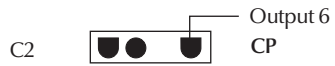
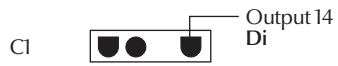
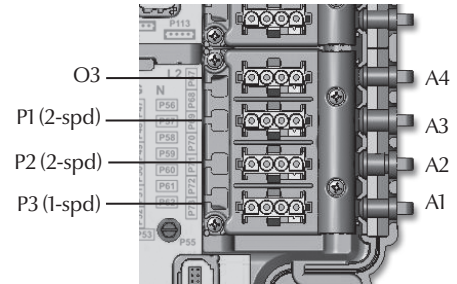
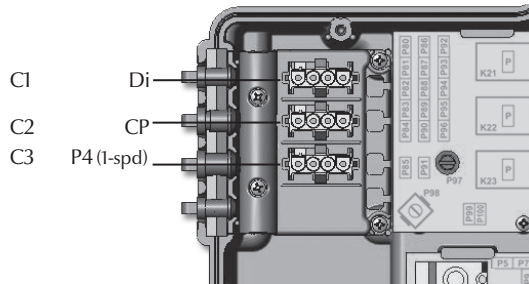





# Typical output configurations

in.yt-12

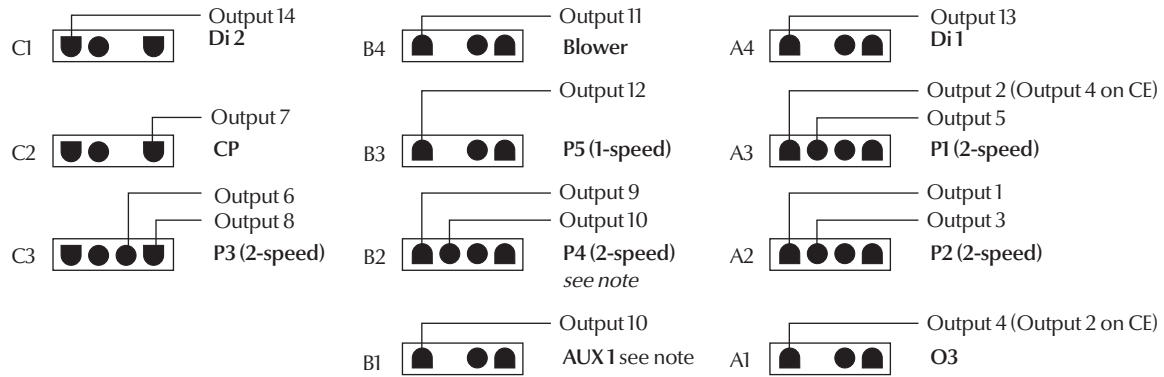
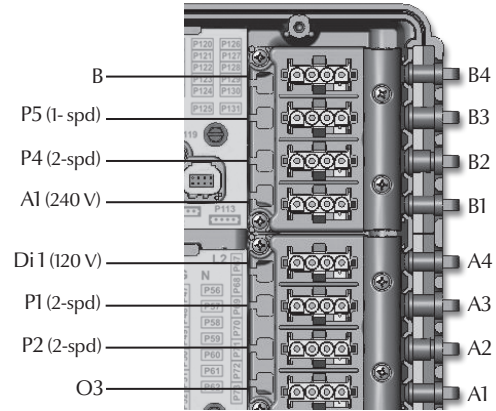
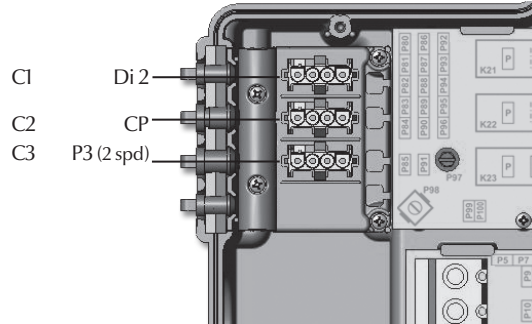

Note: If P4 2 speed is used, AUX1 can not be used.



## Output cables

### Output cable opening size

in.yt

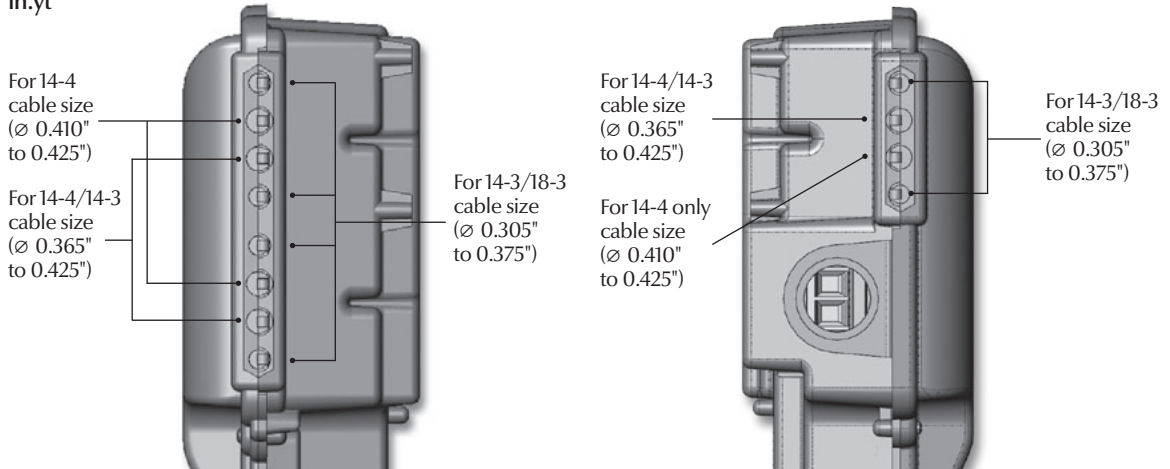

in.ye

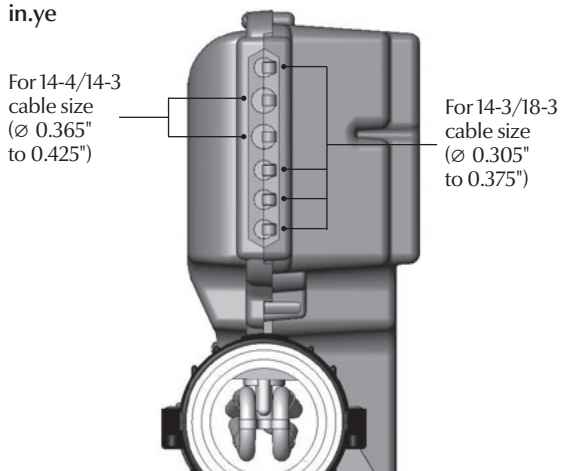

### Output cable installation

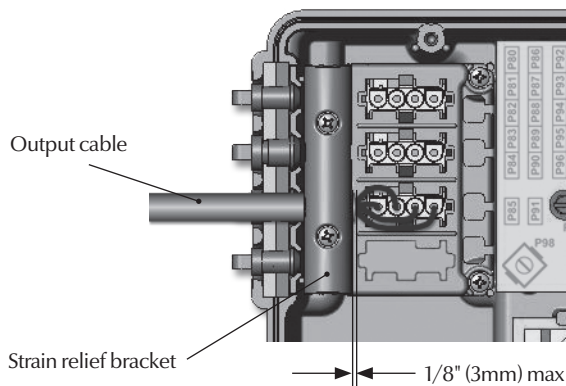

The cable jacket must not exceed the strain relief bracket more than 1/8" (3mm).



## Y Series field programming options

### AMP pins and housings

A special PP-1 splitter can be ordered (Part #: 9920-401369) and used to split an output into 2 parallel outputs (i.e. a single O3 output could be used for an ozonator and UV generator, O3 or CP). Both accessories driven must be of the same operating voltage (120 V or 240 V).

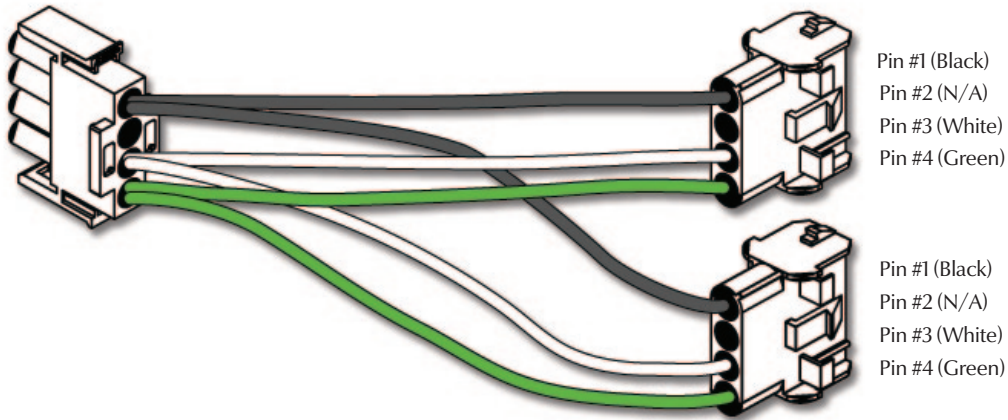



## Y Series field programming options

### Custom configurations

In the event that none of the predetermined low-level program configurations built in the unit's system suit your spa equipment assembly, it's possible to custom configure the system by manually entering key parameter settings (see Table 1). To access this menu, press and hold the **Prog** (or **Light** key) for 30 seconds. Use the **Up/Down** keys to choose setting. Press the **Prog** key (or **Light** key) to go to the next parameter. Parameters available will depend on your model.

Table 1

Parameter	Display	Options	Description
Output 1	1. . .	--,1H,1L,2H,2L,3H,3L,4H,4L,P5,BL,CP,O3,L2,H, ON	Accessory connected to relay Output 1
Output 2	2. . .	--,1H,1L,2H,2L,3H,3L,4H,4L,P5,BL,CP,O3,L2,H, ON	Accessory connected to relay Output 2
Output 3	3. . .	--,1H,1L,2H,2L,3H,3L,4H,4L,P5,BL,CP,O3,L2,H, ON	Accessory connected to relay Output 3
Output 4	4. . .	--,1H,1L,2H,2L,3H,3L,4H,4L,P5,BL,CP,O3,L2,H, ON	Accessory connected to relay Output 4
Output 5	5. . .	--,1H,1L,2H,2L,3H,3L,4H,4L,P5,BL,CP,O3,L2,H, ON	Accessory connected to relay Output 5
Output 6	6. . .	--,1H,1L,2H,2L,3H,3L,4H,4L,P5,BL,CP,O3,L2,H, ON	Accessory connected to relay Output 6
Output 7	7. . .	--,1H,1L,2H,2L,3H,3L,4H,4L,P5,BL,CP,O3,L2,H, ON	Accessory connected to relay Output 7
Output 8	8. . .	--,1H,1L,2H,2L,3H,3L,4H,4L,P5,BL,CP,O3,L2,H, ON	Accessory connected to relay Output 8
Output 9	9. . .	--,1H,1L,2H,2L,3H,3L,4H,4L,P5,BL,CP,O3,L2,H, ON	Accessory connected to relay Output 9
Output 10	A. . .	--,1H,1L,2H,2L,3H,3L,4H,4L,P5,BL,CP,O3,L2,H, ON	Accessory connected to relay Output 10
Output 11	b. . .	--,1H,1L,2H,2L,3H,3L,4H,4L,P5,BL,CP,O3,L2,H, ON	Accessory connected to relay Output 11
Output 12	C. . .	--,1H,1L,2H,2L,3H,3L,4H,4L,P5,BL,CP,O3,L2,H, ON	Accessory connected to relay Output 12
Output 13	d. . .	--,CP	Accessory connected to the Direct Output 1
Output 14	E. . .	--,CP	Accessory connected to the Direct Output 2
Heater	H. . .	--,H	Accessory connected to the heater relay
CP usage	Cu. .	CP Standard = 0 CP Always On = 1	Usage of the circulation pump
Ozone usage	Ou. .	Ozone with filtration = 0 Ozone Always On = 1	Usage of the ozone generator
Ozone Pump	oP. .	Circulation pump = 0 Pump #1 = 1	Pump associated with the ozone generator
Ozone Type	o. .	Standard (UV) = 0 Timed (Corona) = 1	Type of ozone generator
Heater Pump	HP. .	Circulation pump = 0 Pump #1 = 1	Pump associated with the Heater
Filter Config	FL. .	Purge only = 0 Start/Dur/Freq with CP = 1 Start/Dur/Freq with P1 = 2 Duration only with P1 = 3	Filter cycle configuration
Temp. Units	Un. .	°F = 0 °C = 1	Temperature units used on display
Clock Format	CL. .	No time display = 0 AM/PM format = 1 24H format = 2	Clock display format



## Y Series field programming options

Table 1 (Continued)

Parameter	Display	Options	Description																				
Cool down	C_..	30 to 240 seconds	Cool down of the heating element in seconds																				
Output 1 current	1_..	0 to 15 amperes	Current draw of Output 1 accessory																				
Output 2 current	2_..	0 to 15 amperes	Current draw of Output 2 accessory																				
Output 3 current	3_..	0 to 15 amperes	Current draw of Output 3 accessory																				
Output 4 current	4_..	0 to 15 amperes	Current draw of Output 4 accessory																				
Output 5 current	5_..	0 to 15 amperes	Current draw of Output 5 accessory																				
Output 6 current	6_..	0 to 15 amperes	Current draw of Output 6 accessory																				
Output 7 current	7_..	0 to 15 amperes	Current draw of Output 7 accessory																				
Output 8 current	8_..	0 to 15 amperes	Current draw of Output 8 accessory																				
Output 9 current	9_..	0 to 15 amperes	Current draw of Output 9 accessory																				
Output A current	A_..	0 to 15 amperes	Current draw of Output 10 accessory																				
Output B current	b_..	0 to 15 amperes	Current draw of Output 11 accessory																				
Output C current	C_..	0 to 15 amperes	Current draw of Output 12 accessory																				
Output D current	d_..	0 to 5 amperes	Current draw of Direct output 1 accessory																				
Output E current	E_..	0 to 5 amperes	Current draw of Direct output 2 accessory																				
Output H current	H_..	0 to 23 amperes	Current draw of the heater																				
CE Configuration	CE_	UL = 0 CE = 1	CE or UL setup																				
Number of phases	P_..	1 or 2 (UL) 1, 2 or 3 (CE)	Number of Phases / Breakers <b>Number of Phases selection</b> UL            Menu not available CE            1, 2 or 3 UL Swim     1 or 2 CE Swim     1, 2 or 3																				
Input current	b_..	10 to 60A Single Phase (UL and CE) 10 to 48A Dual Phase (UL) 10 to 40A Dual Phase (CE) 10 to 20A Triple Phase (CE)	Available household current <b>Maximum Input Current</b> <table border="1"> <thead> <tr> <th></th> <th>1 phase</th> <th>2 Phases</th> <th>3 Phases</th> </tr> </thead> <tbody> <tr> <td>UL</td> <td>48</td> <td>na</td> <td>na</td> </tr> <tr> <td>CE</td> <td>48</td> <td>20</td> <td>16</td> </tr> <tr> <td>UL Swim</td> <td>60</td> <td>48</td> <td>na</td> </tr> <tr> <td>CE Swim</td> <td>60</td> <td>40</td> <td>20</td> </tr> </tbody> </table>		1 phase	2 Phases	3 Phases	UL	48	na	na	CE	48	20	16	UL Swim	60	48	na	CE Swim	60	40	20
	1 phase	2 Phases	3 Phases																				
UL	48	na	na																				
CE	48	20	16																				
UL Swim	60	48	na																				
CE Swim	60	40	20																				

---

## Keypad overview



The following instructions are generic and provide a quick overview of the main keypad functions. Please refer to your own QRC for specific functions.

The Y Series spa pack is compatible with the following keypads: in.k200, in.k300, in.k400, in.k450, in.k500, in.k600 (streamlined), K-4, K-19, K-35, K-8 (with in.link connector) and in.k800 (color display).



## Keypad overview

### Function description

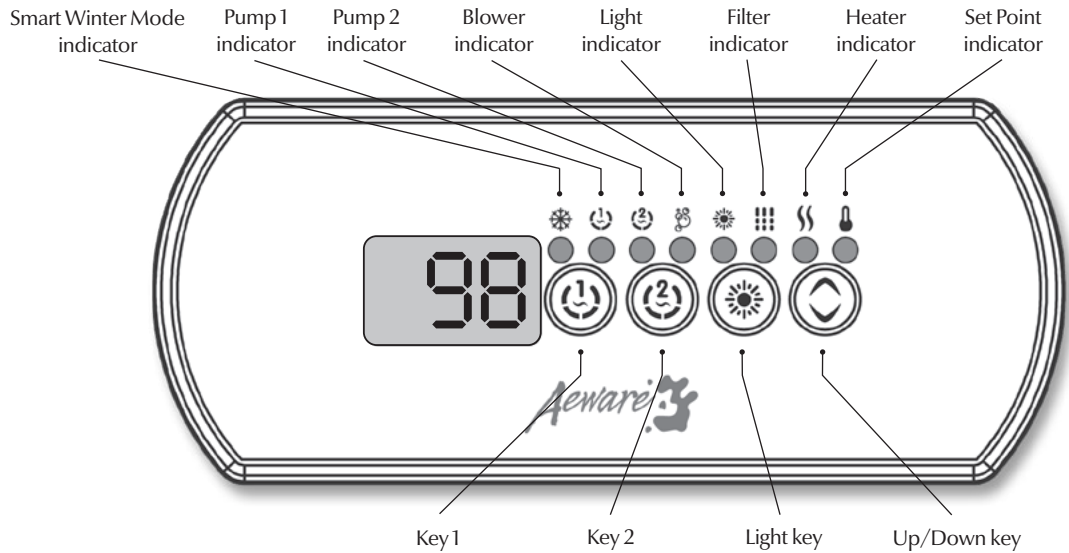

### Instructions

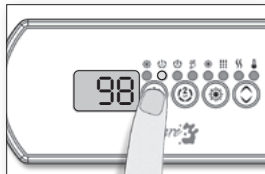

#### Key 1

Press **Key 1** to turn pump 1 on at low speed. Press a second time to turn pump to high speed (with a dual-speed pump). A third time turns the pump off.

A built-in timer automatically turns pump off after a predetermined period of time, unless it has been manually deactivated.

The Pump 1 indicator lights up when pump 1 is on. With dual-speed pump, the indicator will flash when pump 1 is on at low speed.

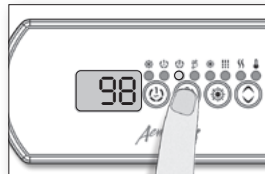

#### Key 2

(single pump or blower)

Press **Key 2** to turn pump 2 or the blower on. Press a second time to turn the pump or blower off.

A built-in timer automatically turns the pump off after a predetermined period of time, unless it has been manually deactivated.

The Pump 2 and/or Blower indicator lights up when the corresponding output is on.

*Note: with dual-speed pump, the indicator will flash when Pump 2 is on at low speed.*

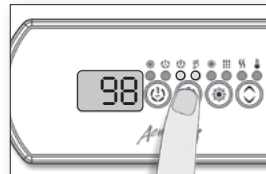

#### Key 2

(single pump & blower)

Press **Key 2** to turn Pump 2 on at high speed. Pressing a second time turns blower on. A third press turns Pump 2 off but leaves blower on. A final press turns blower off.

A built-in timer automatically turns pump/blower off after a predetermined period of time, unless it has been manually deactivated.

The Pump 2 and/or Blower indicator lights up when the corresponding output is on.

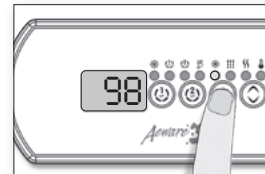

#### Light key

Press the **Light** key to turn light on. Press the **Light** key a second time to turn light off.

A built-in timer automatically turns light off after a predetermined period of time, unless it has been manually deactivated.

The Light indicator lights up when light is on.

## Keypad overview

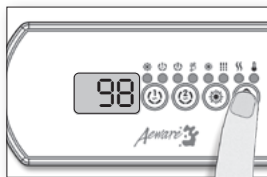

### Up/Down key

Use the Up/Down keys to set desired water temperature. The temperature setting will be displayed for 5 seconds to confirm your new selection.

When the Set Point indicator is lit the display shows the desired temperature, NOT the current water temperature!

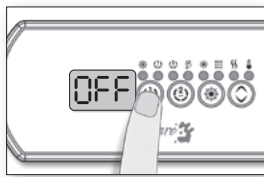

### Off Mode

This mode allows you to stop all outputs for 30 minutes to perform a quick spa maintenance.

Press and hold Key 1 for 5 sec. to activate the Off mode. Press Key 1 to reactivate the system before the expiration of the 30 minute delay.

While the Off mode is engaged, the display will toggle between OFF and the water temperature.

### Programming the system

Depending on system configuration the system performs either purge cycles or filter cycles.

### Filter cycles

To program the filter cycles, you must enter the duration and frequency. During a filter cycle, pumps & blower run at high speed for one minute to purge the plumbing. Pump 1 or CP then runs at low speed for the remainder of the cycle.

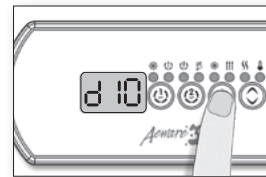

### Setting filter cycle duration

Press and hold the Prog or Light key until the display shows d xx, with "xx" representing the duration in hours.

Use the Up/Down keys to change setting.

0 = no filtration  
24 = continuous filtration

*Note: it's not recommended to set this to "0".*

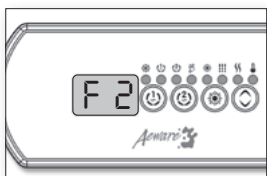

### Filter cycle frequency

Press the Prog or Light key again. The display will show Fx, with "x" representing the number of filter cycles per day (up to 4).

Use the Up/Down keys to change the setting.

When the desired setting is displayed, Press the Light key to confirm. A filter cycle will start immediately.

The Filter indicator lights up when a filter cycle is on.



### Purge cycle frequency

Press and hold the Light key until the display shows Fx, with "x" representing the number of purge cycles per day (up to 4).

Use the Up/Down keys to change setting.

When the desired setting is displayed, Press the Light key to confirm. A purge cycle will start immediately.

The Filter indicator lights up when a purge cycle is on.

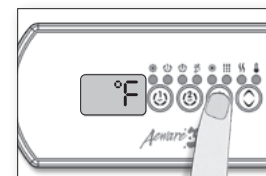

### Setting the temperature display units

Press the Light key again.

The display will show either °F or °C.

Use the Up/Down keys to change units.

Press the Light key a last time to go back to normal mode.

°F = Fahrenheit  
°C = Celsius





## Keypad overview



### Water temperature regulation

In a regulation cycle, the system first generates water flow through the heater housing and the plumbing, in order to ensure accurate water temperature readings as well as avoiding heater activation in dry conditions.

The system verifies periodically that all parameters are within normal range.

If the readings received from the system are not valid, blanks (- - -) will be displayed until normal readings have been successfully recorded.

After verifying pump activation and taking a water temperature reading if required, the system automatically turns the heater on to reach and maintain water temperature at Set Point. The Heater indicator lights up when the heater is on. It flashes when there is a request for more heat but the heater has not yet started.



### Smart Winter Mode

Our Smart Winter Mode protects your system from the cold by turning pumps on several times a day to prevent water from freezing in pipes. The Smart Winter Mode indicator lights up when the Smart Winter Mode is on.

### Cool down

After heating the spa water to the desired Set Point, the heater is turned off, but its associated pump (Pump 1 low-speed or CP) remains on for a certain amount of time to ensure adequate cooling of the heating element, prolonging its life.

The Heater icon flashes during this time.

## Typical settings

Adjustable Regulating Set Point:	59°F (15°C) to 104°F (40°C)
Factory Default Set Point:	Typical 95°F (35°C) / Max 100°F (38°C)
Filter Cycle Duration:	0 to 24 hrs / Factory set at 2hrs
Filter Cycle Frequency:	1 to 4 times a day / Factory set at 2
Filter Cycle Start:	00:00 to 23:59 / Factory set at 12:00
Pump Runtime:	Factory set at 20 min.
Light Timeout:	Factory set at 120 min.

## Keypads available for the Y Series:



K-19



K-35

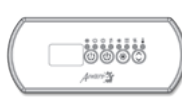

in.k200 (LED display, 4 keys, 8 light indicators)



in.k600 (streamlined)



in.k300

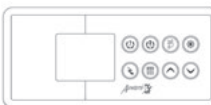

K-4



K-8



in.k450 (LCD display, 6 keys, 10 function icons)



in.k800



in.k500

## Troubleshooting

### Y Series error codes

Error codes indicate a failure condition or a problem which needs to be corrected to ensure proper functioning of the system. Both the error code and the water temperature are alternatively displayed.

All errors codes will be displayed on the keypad display.

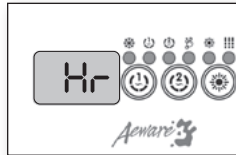

#### Hr

An internal hardware error has been detected in the spa pack.

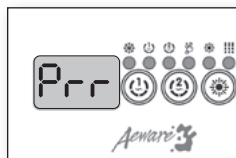

#### Prr

The Prr error message indicates a problem with the regulation probe. The system is constantly verifying if temperature probe reading is within normal limits.

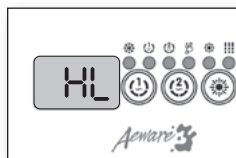

#### HL

Water temperature at the heater has reached 119°F.  
**Do not enter spa water!**



#### FLO

The system did not detect any water flow while the main pump was running.



#### UPL

No low-level configuration software has been downloaded into the system.



#### AOH

Temperature inside the spa skirt is too high, causing the internal temperature in the spa pack to go above normal limits.



#### OH

Water temperature in the spa has reached 108°F.  
**Do not enter spa water!**



## Troubleshooting

### Hr error message



An internal hardware error has been detected

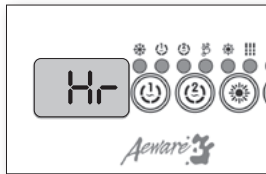

- Restart the spa pack and start & stop all pumps and blower.
- If error reappears, replace the spa pack.

### Prr error message



Regulation probe issue

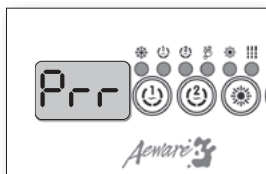

Regulation probe

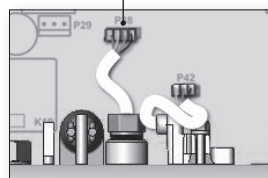

- Verify if regulation probe (located above the heater) is properly connected.
- Replace heater if problem persists.
- Replace spa pack, if problem persists.

# Troubleshooting

## HL error message



The system has shut down because the temperature at the heater has reached 119°F (48°C).

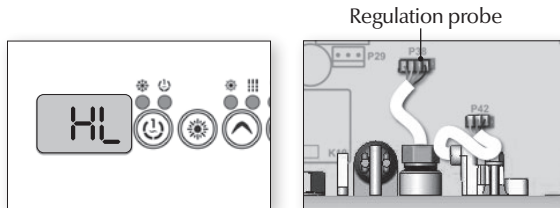

- Measure the temperature with a DIGITAL thermometer and compare its reading with temperature on the display.

### If reading is below 119°F:

- Carefully check if heater barrel feels hot. If it's hot, check that nothing is obstructing water flow (closed valves or dirty filter).
- If it is not hot, check that the Hi-Limit probe is properly connected.
- Shut power off and power the spa up again to reset the system.
- If HL error persists, replace heat.wav.
- If HL error persists, replace spa pack.

### If reading is 119°F or higher and does not match temperature on the display:

- Verify that the Temp. & High Limit probes are properly connected.
- If cable is connected, replace heat.wav
- Shut power off and power the spa up again to reset the system.
- If HL error persists replace spa pack.

### If reading is 119°F or higher and weather is very hot:

- Remove spa cover (even during the night).
- Start blower if spa is equipped with one.
- Wait until spa cools down (add cold water if necessary).
- Shut power off and power the spa up again to reset the system.

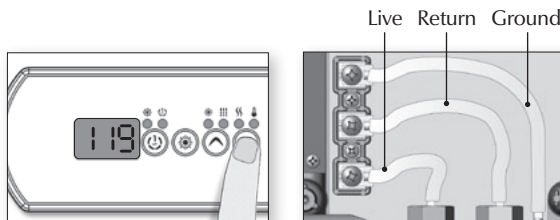

### If reading is 119°F or higher and hot weather is not an issue:

- Lower Set Point below current water temperature. The Heater indicator should disappear from keypad display.
- With a voltmeter, read voltage between the live and ground heater terminals located in the spa pack.
- If you read 120 V or 240 V, replace spa pack.
- If you do not read 120 V or 240 V, pump may be overheating water during filter cycle.
- Shorten filter cycle duration.
- Shut power off and power the spa up again.



## Troubleshooting

### FLO error message

**FLO**

The system did not detect any water flow while the primary pump was running.

Make sure that the low-level programming has been properly set, with or without circulation pump (depending on your system configuration).

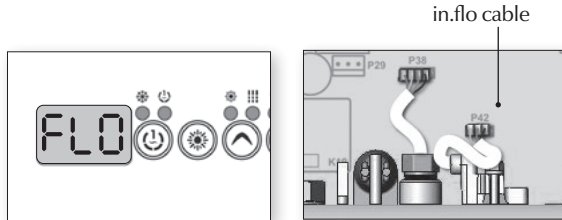

- Make sure water valves are open and that water level is high enough.
- Check and remove anything obstructing the filter.
- Make sure there is adequate flow (minimum 18 GPM)
- Make sure that no airlocks are trapped in the unit's plumbing (pumps may make strange noises).  
If airlocks are formed, start the pump and slowly loosen one of the union nuts to release the air trapped in the plumbing.  
Tighten the nut again after you are done.
- Make sure that the pump associated to the heater (primary pump) is running.
- Make sure the in.flo cable (located above the heater) is properly connected.
- If problem persists replace heat.wav.
- If the problem is not solved replace the spa pack.

## Troubleshooting

### OH error message

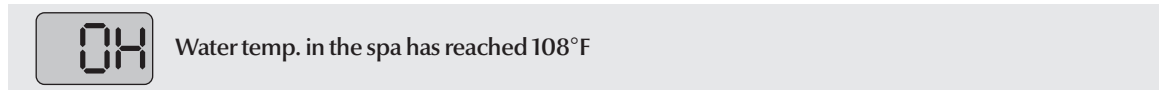

- Measure water temperature with a DIGITAL thermometer and compare its reading with the temperature on the display.

#### If temperature reading is different:

- Shut power off and power the spa up again to reset the system.
- If OH error persists, replace heat.wav.
- If OH persists, replace spa pack.

#### If temperature on display is correct (above 108°F) and weather is hot:

- Remove spa cover and let spa cool down.
- Add cold water and shorten filter cycle duration.
- If problem persists replace spa pack.

#### If temperature on display is correct (above 108°F) and hot weather is not a factor:

- Lower Set Point below current water temperature. The Heater indicator should disappear from the keypad display.
- Turn off all pumps. If a pump is still running, replace spa pack.
- If not, the pump may be overheating the water during filter cycle. Shorten filter cycle duration.

### UPL error message

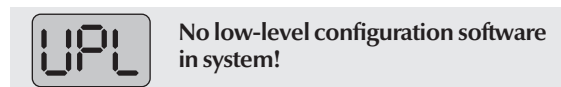

- New low-level configuration software needs to be downloaded into the spa system; without it the system will not be operable.

- Contact our toll free line for technical support (1-800-784-3256).

*Note: this line is dedicated to assist authorized service technicians and dealers only.*



# Troubleshooting

## Pump 1 doesn't work

Pump 1 is not working.

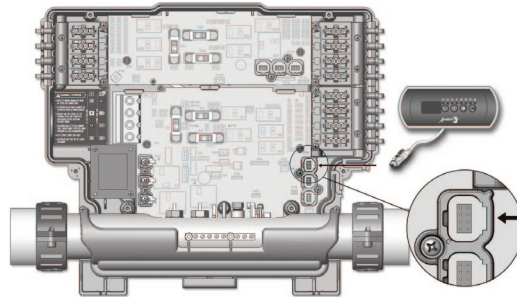
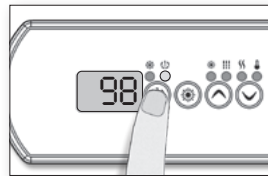

- Check for an error message on keypad display. If there is one, refer to the specific section indicated by the error message.
- Verify low-level programming configuration.

- Check if the Pump 1 indicator appears on keypad display when you press Key 1.

### If the Pump 1 indicator does not appear:

- Use a spare keypad to verify if keypad is defective.
- If it is, replace keypad.
- If not, replace spa pack.

### If Pump 1 indicator appears:

- Verify if pump works in either speed.

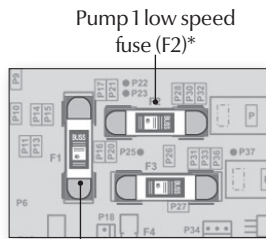

Pump 1 high speed fuse (F1)

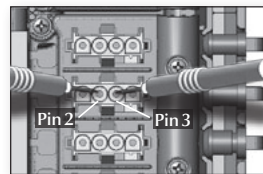
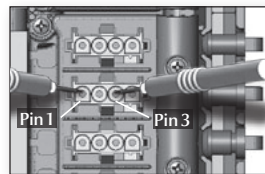

### If Pump 1 does not work in either speed:

- Replace appropriate Pump 1 fuse.

If replacing the fuse is not effective or if Pump 1 works in only one speed, take a voltage reading on the corresponding connector.

### If Pump 1 works in one speed, or replacing the fuse did not work:

- Turn Pump 1 to high speed and take voltage reading between: Pin 1 and Pin 3

Your reading should be:

240 V for a 240 V pump

120 V for a 120 V pump

- Turn Pump 1 to low speed and take voltage reading between: Pin 2 and Pin 3

Your reading should be:

240 V for a 240 V pump

120 V for a 120 V pump

**If voltage is as it should be, check wiring and plugs, and replace as necessary. Replace Pump 1 if needed.**

**If voltage is not correct, replace spa pack.**

# Troubleshooting

## Pump 2 or blower doesn't work

Pump 2 or blower is not working.

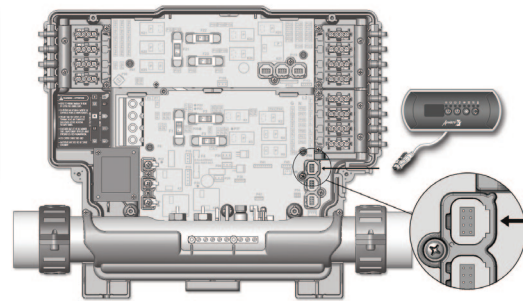
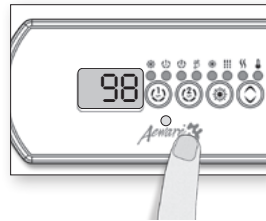

- Check for an error message on keypad display. If there is one, refer to the specific section indicated by the error message.
- Verify low-level programming configuration.
- Check if the Pump2 or Blower indicator appears on keypad display when you press the corresponding key.

### If the indicator does not appear:

- Use a spare keypad to verify if keypad is defective.
- If it is, replace keypad.
- If not, replace spa pack.

### If indicator appears:

- Replace blower fuse.
- Verify if pump 2 works in either speed (for dual speed pumps).

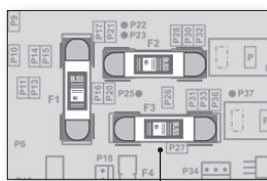

Pump 2 fuse (F3)

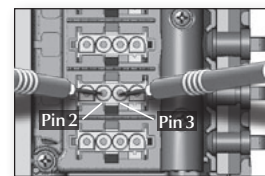
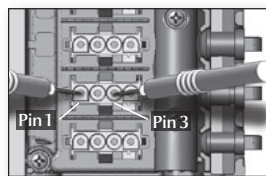

### If Pump 2 does not work in either speed:

- Replace appropriate Pump 2 fuse.

### If Pump 2/blower does not work, works in one speed (dual speed pumps), or replacing the fuse did not work:

- Turn Pump 2 to high speed and take voltage reading between: Pin 1 and Pin 3

Your reading should be:

240 V for a 240 V pump

120 V for a 120 V pump

- Turn Pump 2 to low speed and take voltage reading between: Pin 2 and Pin 3

Your reading should be:

240 V for a 240 V pump

120 V for a 120 V pump

**If voltage is as it should be, check wiring and plugs, and replace as necessary. Replace Pump 2 if needed.**

**If voltage is not correct, replace spa pack.**





## Troubleshooting

### Circulation pump doesn't work

Circulation pump is not working.

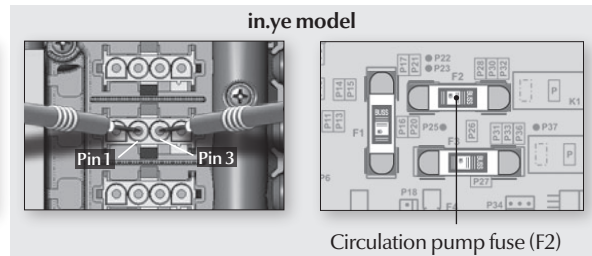
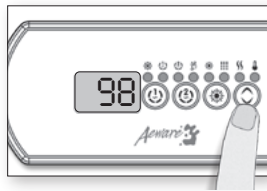
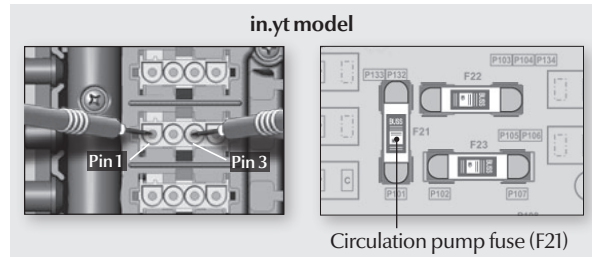

#### If circulation pump is not working:

- Verify low-level programming configuration.
- Start circulation pump by setting temperature set point 2 °F higher than actual water temperature.

- Take voltage reading on the corresponding AMP connector:  
Pin 1 & Pin 3  
  
Your reading should be:  
240 V for a 240 V pump  
  
120 V for a 120 V pump

#### If you don't get a voltage reading:

- Replace the accessory fuse.
- If changing the fuse does not fix the problem, replace the spa pack.

#### If voltage is as it should be:

- Replace circulation pump.

## Troubleshooting

### Ozonator doesn't work

Ozonator is not working.

Ozonator output will be shut down when Pump 1, Pump 2 or blower have been turned on manually.

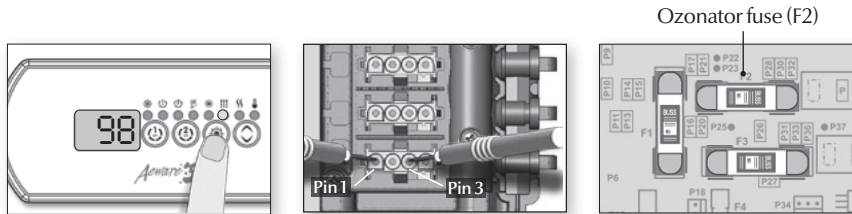

#### If the ozonator is not working:

- Check if Filter Cycle indicator appears steady on keypad.
- If the filter indicator is blinking it indicates that the filter cycle has been interrupted. In that case, reset the breaker by turning the power off and on again to resume cycle.
- If not, start up a filter cycle (see Programming Filter Cycles section).
- If ozonator does not work even when Filter Cycle indicator is on, or indicator does not light up, take voltage reading on the corresponding AMP connector: Pin 1 & Pin 3  
Your reading should be:  
240 V for a 240 V pump  
120 V for a 120 V pump

If you don't get a voltage reading, replace the accessory fuse.

If changing the fuse does not fix the problem, replace the spa pack.

If voltage is as it should be, replace ozonator.



## Troubleshooting

### Nothing seems to work: North American models

Verify that all screws are properly tightened on the terminal block. Turn power off and make sure that all cables hold firmly in the terminal block if you pull on them. Once done, turn power back on.

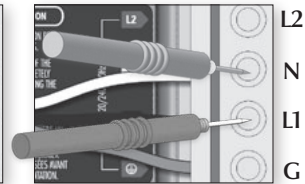
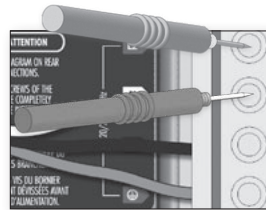
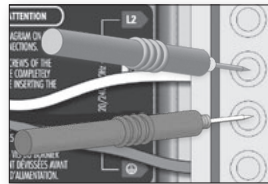
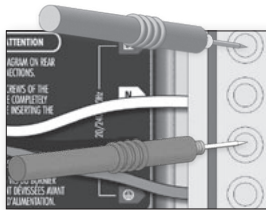

#### For 240 V systems

- On the terminal block, measure voltage between line 1 and line 2.
- You should get 240 V.
- Measure voltage between line 1 and neutral.
- You should get 120 V.
- Measure voltage between line 2 and neutral.
- You should get 120 V.

#### For 120 V systems

- Measure voltage between line 1 and neutral.
- You should get 120 V.

If you do not get good readings, this indicates an electrical wiring problem.

Call an electrician!

If the voltage readings are OK then:

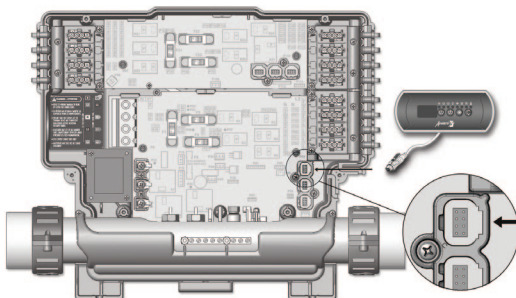

- Verify if keypad is correctly connected to the spa pack.

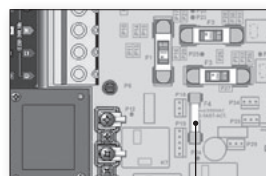

Transformer fuse

- Verify the transformer fuse.
- Replace transformer fuse if necessary.
- If problem persists, replace spa pack.

# Troubleshooting

## Nothing seems to work: European models

Verify that all screws are properly tightened on the terminal block. Turn power off and make sure that all cables hold firmly in the terminal block if you pull on them. Once done, turn power back on.

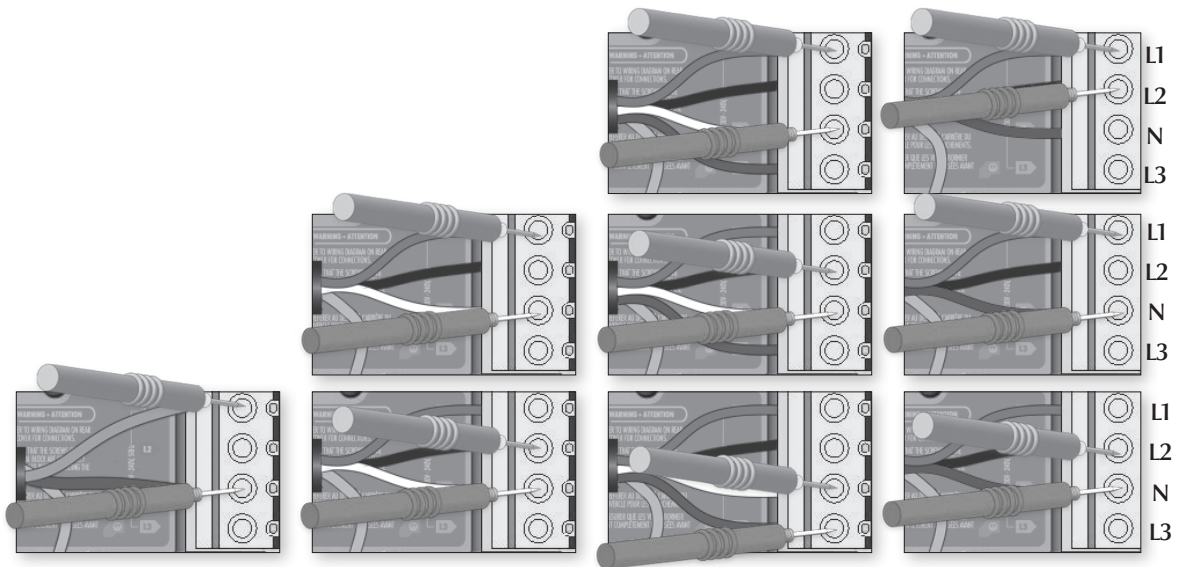

### For 1-phase system

- On the terminal block, measure voltage between line 1 and neutral.
- You should get 230 V.
- If you do not get good readings, this indicates an electrical wiring problem.

**Call an electrician!**

### For 2-phase system

- Measure voltage between line 1 and neutral and between line 2 and neutral.
- You should get 230 V on both readings.
- If you do not get good readings, this indicates an electrical wiring problem.

**Call an electrician!**

### For 3-phase system

- Measure voltage between line 1 and neutral, between line 2 and neutral and between line 3 and neutral.
- You should get 230 V for each reading.
- If you do not get good readings, this indicates an electrical wiring problem.

**Call an electrician!**

### For 3-phase Delta system

- Measure voltage between line 1 and line 2, between line 1 and line 3 and between line 2 and line 3.
- You should get 230 V for each reading.
- If you do not get good readings, this indicates an electrical wiring problem.

**Call an electrician!**

If the voltage readings are OK then:

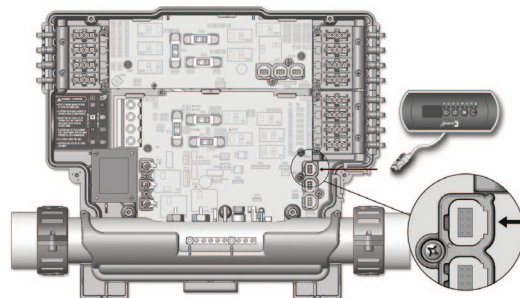

- Verify if keypad is correctly connected to the spa pack.

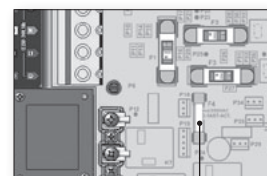

Transformer fuse

- Verify the transformer fuse.
- Replace transformer fuse if necessary.
- If problem persists, replace spa pack.



## Troubleshooting

### Spa not heating

Set Point indicator

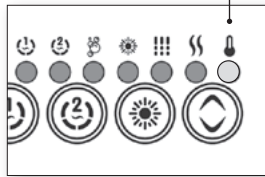

Heater indicator

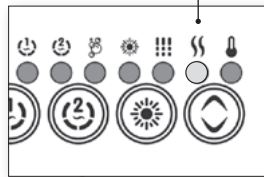

Live Return Ground

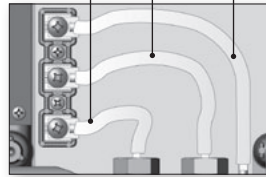

Heater fuse (F1)  
(CE Model only)

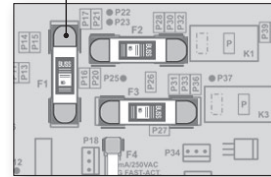

- Check for an error message on keypad display. If there is one, refer to specific section indicated by the error message.
- If there is no error message, try to raise water temperature by increasing the Set Point 2°F higher than actual water temperature. Press Up key to increase Set Point.

- Check if Heater indicator appears on keypad display.  
  
The Heater indicator will be on when heater is on. It will flash if more heat has been requested, but heater has not started yet.

#### If Heater indicator lights up on the display:

- Take voltage reading between the heater live and return terminals.

Your reading should be:

240 V: for spa packs configured in 240 V

120 V: for spa packs configured in 120 V

If voltage reading is not as it should be, check that heater terminals are properly connected. If they are, replace spa pack.

In the case of the European model in.yt.ce only, replace accessory fuse.

If voltage reading is as it should be, verify that the heat.wav power cable is properly connected to the terminal screws in the spa pack. If they are, replace heat.wav.

#### If Heater indicator does not light up on the display, measure water temperature and compare with temperature on display:

- If less than 2°F difference, there is no problem.
- If greater than 2°F difference, replace the heat.wav.
- If problem persists, replace the spa pack.

### Keypad doesn't seem to work

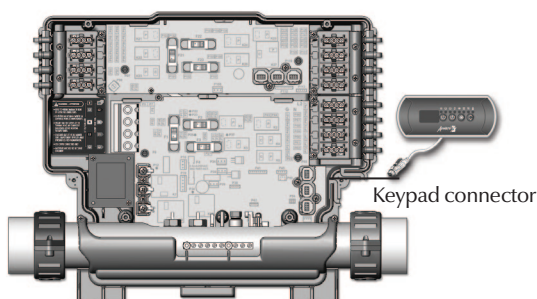

If a keypad doesn't work:

- Verify keypad connections and try spare keypad.
- Replace keypad if problem is corrected.
- Replace pack if problem is not corrected.

# Troubleshooting

## GFCI/RCD trips

Main electrical box

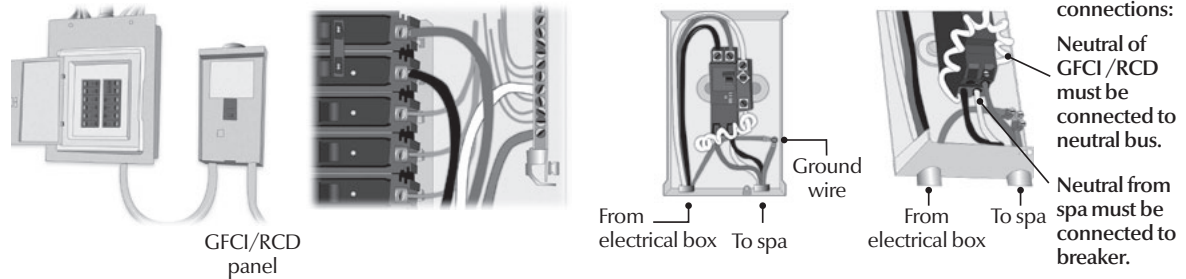

**Warning!**

**Total current output cannot exceed total current input rating!**

There are different GFCI/RCD models used on the market. See manufacturer's instructions that come with the GFCI/RCD for specific information. Note that all illustrations are examples only.

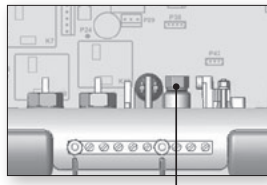

GFCI/RCD (J1)

The Y Series packs are equipped with a GFCI/RCD tripper circuit in case an HL error occurs.

- Find the GFCI/RCD tripper circuit (J1) on the board located behind the temperature probe and remove the jumper.
- Reset the GFCI/RCD and see if an error occurs. If HL appears, follow the HL error troubleshooting chart (in the Troubleshooting section).
- If no error occurs, re-install the jumper.

*Note: If the GFCI/RCD trips only when jumper (J1) is installed, replace the spa pack.*

The GFCI/RCD trips and the jumper (J1) is not installed, the error doesn't come from the GFCI/RCD tripper circuit.

- Verify that the GFCI/RCD circuit is properly connected.
- If it's not, reconnect it.
- Verify the spa pack wiring (make sure that the neutral and the ground have not been inverted)

**If the GFCI/RCD is properly connected but still tripping,**

- Unplug all outputs from the spa pack (pumps, blower, heater, ozonator etc).
- If it doesn't trip while all outputs are unplugged, reconnect one output at a time until the GFCI/RCD trips again.
- Replace defective component.

*Note: Incorrect GFCI/RCD wiring may lead to a condition where the GFCI/RCD may NOT trip when it should, causing electrical shock hazard. All electrical installations should be done by qualified personnel only.*



## Step-by-step field replacement procedure

### Y Series

#### Step-by-step field replacement procedure

As part of our technical support services, this section provides proper step-by-step methods to facilitate the replacement of Y Series spa packs in the field.

##### Tools needed:

- Phillips & flat screwdrivers
- Multimeter
- Open-ended adjustable wrench
- Scraper tool
- Pliers
- GFCI tester

All procedures described in this service manual must only be performed by qualified personnel, in accordance with the standards applicable in the country of installation.

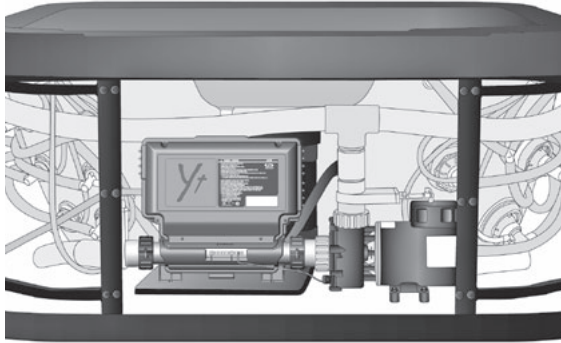

#### How to remove a spa pack from the spa piping.

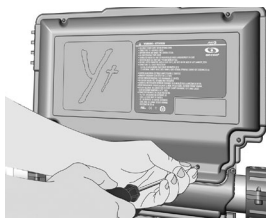

##### ⚠ Warning!

When replacing a Y Series spa pack, it's very important to make sure to turn power off before proceeding.

With a Phillips screwdriver loosen the screws of the spa pack cover and remove it.

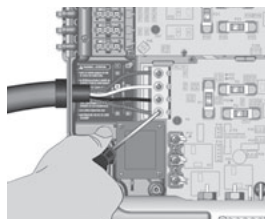

Disconnect incoming power lines by loosening the screws on the terminals of the terminal block.

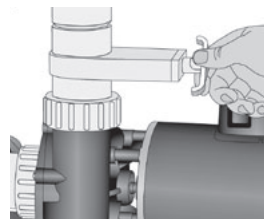

Carefully revise the spa plumbing schematics and identify the spa **Flow Shut Off Valves**. Make sure that both **Flow Shut Off Valves**, which control water inlet before and after the heater, are closed.

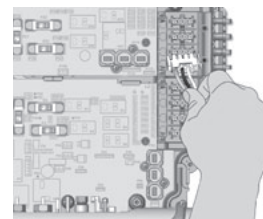

Remove the cable strain relief cover (3 screws) and the cable strain relief bracket (1 screw).

Unplug power cord by squeezing the latches on the side of each AMP plug and pulling it from its socket.

Identify each output cord.

## Step-by-step field replacement procedure

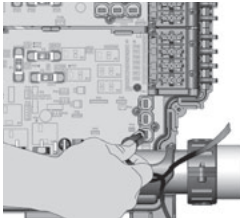

Unplug all low-voltage outputs. e.g.: main keypad, light or any other accessory.

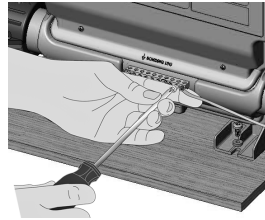

Disconnect the grounding cable from the bonding lug of the spa pack.

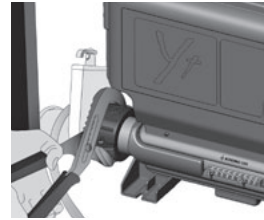

Using a tongue and groove plier loosen both plastic nuts at each end of the unit's heater, as illustrated.

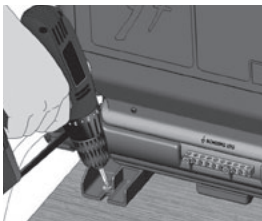
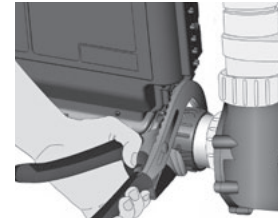

Remove the 2 screws that hold the front of the unit's feet attached to the spa floor.

*Note: the unit can also be wall-mounted. For more details on wall installation procedure refer to the wall installation section of the techbook.*

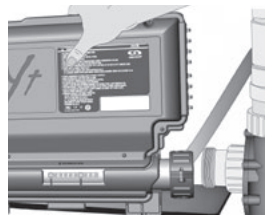

Release the heater nuts from both ends of the spa piping.

Release the spa pack by sliding the unit away from the guide plate that holds the backside of the unit's feet in place.

If the spa pack does not have a guide plate please refer to the installation section of the techbook for more details.

Remove the defective spa pack unit from the spa.

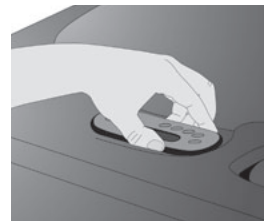

Once that is done, remove the old keypad from the spa.

*Note: the procedure on keypad replacement shown here is for educational purposes only. It is not always necessary to replace the keypad, unless it may be the cause of the malfunctioning of the system. Common sense should prevail.*



When removing the old keypad, make sure to note the exact model, available options etc. Ideally, the new replacement keypad should be of the exact same model as the old one.

If it's not, contact our Technical Support Department for keypad compatibility list.





## Step-by-step field replacement procedure

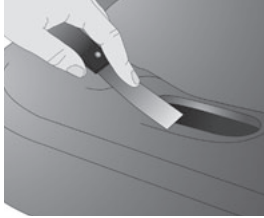

With a scraper tool, gently clean the installation surface of the new keypad, then use an alcohol saturated paper towel to remove any unwanted residue left over from the old keypad.



Feed the cable of the new keypad through the hole opening in the spa.

Orient the cable's connector towards the spa pack to facilitate its connection later.



Insert the keypad in the opening.



Peel off the protective layer from the adhesive on the back of the keypad.

Make sure that the keypad is well aligned and rests perfectly in the recess of the spa.



Secure the keypad in place. Ensure that its adhesive strip is properly glued by pressing evenly with your fingers over the entire surface.



Place a rubber 2" O-ring gasket at the end of each heater nut, to prevent water leakage between the heater nuts and the PVC heater tailpieces.

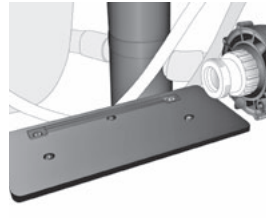

When installing the new spa pack, slide the back side of the unit's feet into the guide plate.

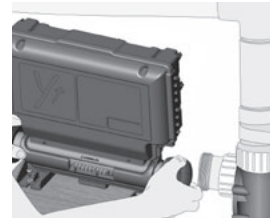

Install the new spa pack in the spa plumbing.

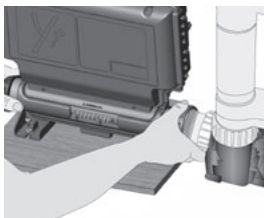

Screw fittings to join to the spa pipe system, making sure that the piping and nut threads are not over-tightened.

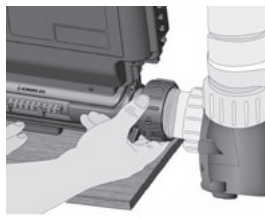

Use an open-ended wrench to tighten both plastic nuts at each end of the unit's heater.

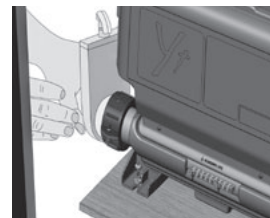
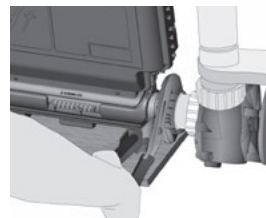

Finally, reopen both flow shut off valves and verify for leaks.

## Step-by-step field replacement procedure

### How to replace the heater

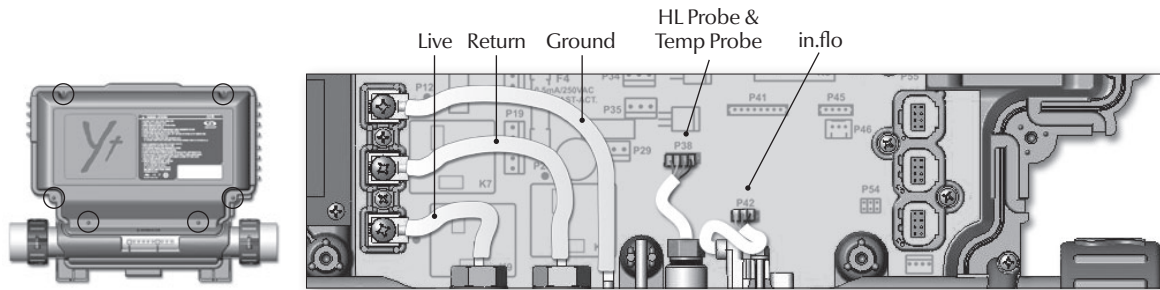

Using a Phillips screwdriver, loosen the screws that hold the cover in place. Use a Phillips screwdriver to loosen the terminals and remove all electrical heater connections: Return, Live and Ground. Manually remove the HL probe & Temp. probe connector.

Manually remove the in.flo connector. Be careful not to damage any connector by twisting or pulling too hard.

**Warning!**

Before starting removal procedure be sure to:

- Turn off electric power to the unit.
- Ensure spa water valves are closed (or that the spa is drained).

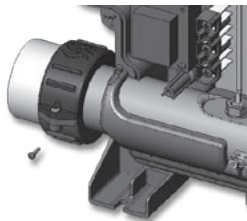

Loosen and remove the 2 screws and disengage the heater bracket. Remove the heater and replace with a new one. Put the heater bracket back in place and secure it with the 2 screws.

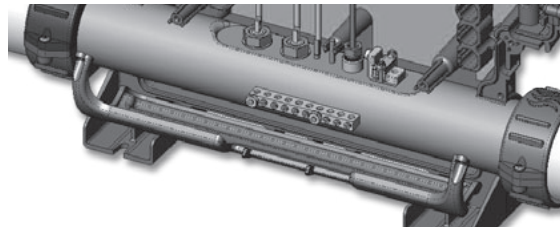

Adjust the heater position and tighten the screws. Plug the in.flo connector back in socket P42. Plug the HL probe and temp probe connectors back in socket P38.

Reconnect the heater connections: Return, Live and Ground. Tighten the screws with a Phillips screwdriver. Put the cover back in place and tighten the screws. Screw fittings to the spa pipe system, making sure that the piping and nut threads are not over tightened.

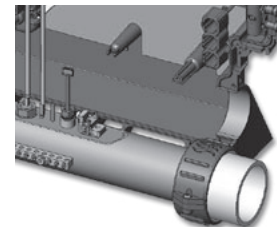

Reopen the spa water valves or fill the spa and check for leaks.



## Step-by-step field replacement procedure

### How to replace the main control board on in.ye

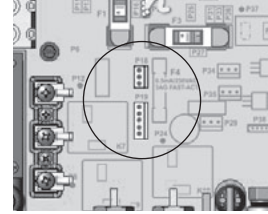
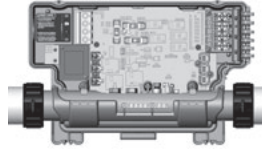
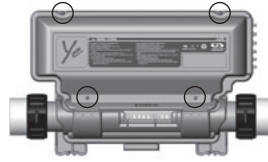

**Warning!**  
Before starting removal procedure be sure to:

- Turn off electric power to the unit.

Using a Phillips screwdriver, loosen the 4 screws that hold the cover in place. Disconnect incoming power lines by loosening the screws on the terminals of the terminal block.

Use a Phillips screwdriver to loosen the terminals and remove all electrical heater connections: Return, Live and Ground. Manually remove the HL probe & Temp. probe connector. Manually remove in.flo connector. Be careful not to damage any connector by twisting or pulling too hard.

Manually remove the transformer connector

Manually remove the topside cable and the in.link cables

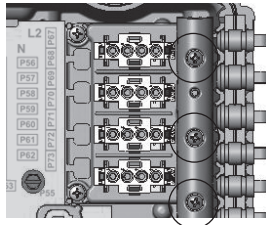

Use a Phillips screwdriver to loosen and remove the cable strain relief cover. Unplug power cord by squeezing the latches on the side of each AMP plug and pulling it from its socket, one at a time, identify each output power cord.

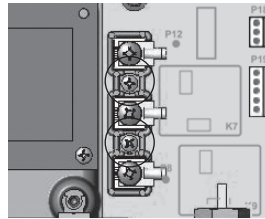

Using the Phillips screwdriver remove the strain relief bracket. Remove the 2 screws from the assembly AMP bracket. Remove the 2 screws of the shroud around the heater's connection post and remove it.

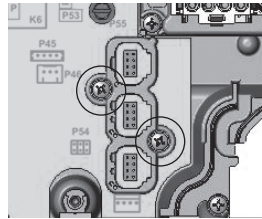

Do the same for the in.link bracket.

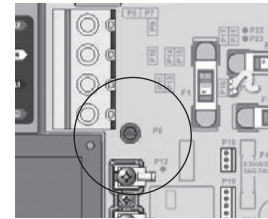

Unscrew the 2 green grounding screws located on either side of the PCB. Slide the PCB down to disengage it from the upper holder. Pull it and slide it upward to remove the card from the in.ye enclosure. Unplug the wires coming from the AMP bracket from the faulty board and replug them in the same location on the new board.

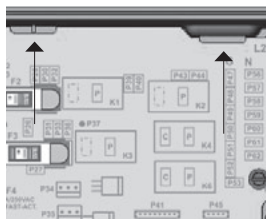

Be sure the ground connection bracket holds in place on the 2 locating pins in the enclosure. Put the new PCB back in the enclosure. Slide it downward, at an incline. Then push it back, just

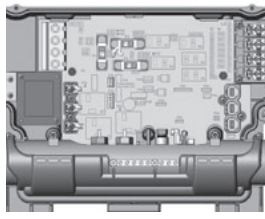

underneath the upper PCB holder, and slide it upward. Install the 2 green ground screws. Be sure the circuit board is lying flat on the back of the enclosure. Put the in.link bracket back in place and

secure it with the 2 screws. Be sure the locating pin is fully in the PCB hole. Install the shroud around the heater's connection posts. Reinstall the AMP assembly bracket. Put the strain relief bracket in place. Plug the topside and in.link cables back in. Plug the output power cord in its initial location. Screw the strain relief cover in place.

Reinstall the transformer connector. Plug the in.flo, the HL probe and temperature probe connectors back in. Plug the heater connections back in: Return, Live, and Ground. Tighten the screws. Connect the incoming power lines and tighten the terminal block screws firmly. Put the cover back in place and tighten the 4 screws.

## Step-by-step field replacement procedure

### How to replace the main control board on in.yt

**Warning!**  
Before starting removal procedure be sure to:

- Turn off electric power to the unit.

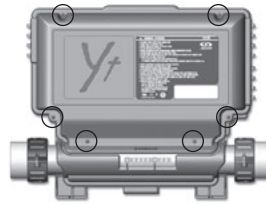

Loosen the 6 screws that hold the cover in place. Disconnect incoming power lines by loosening the screws on the terminals of the terminal block.

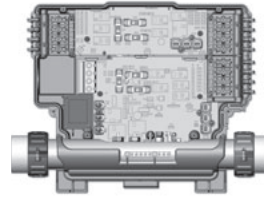

Use a Phillips screwdriver to loosen the terminals and remove all electrical heater connections: Return, Live and Ground. Manually remove the HL probe & Temp. probe connector. Manually remove in.flo connector. Be careful not to damage any connector by twisting or pulling too hard.

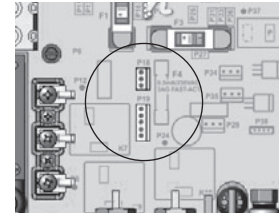

Manually remove the transformer connector.

Manually remove the topside cable and the in.link cables.

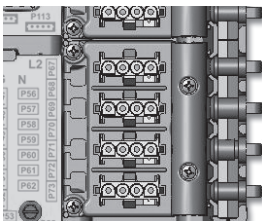

Use a Phillips screwdriver to loosen and remove the cable strain relief cover.

Unplug power cord by squeezing the latches on the side of each AMP plug and pulling it from its socket, one at a time, identify each output power cord.

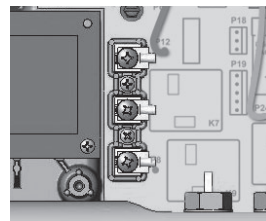

Using the Phillips screwdriver remove the strain relief bracket. Remove the 2 screws from the assembly AMP bracket. Remove the 2 screws of the shroud around the heater's connection post and remove it.

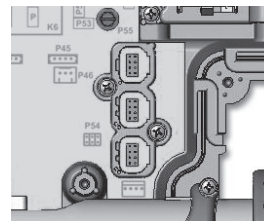

Do the same for the in.link bracket.

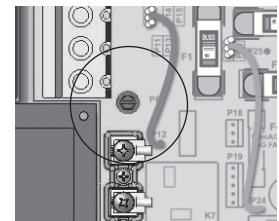

Unscrew the 2 green grounding screws located on either side of the PCB.

Slide the PCB down to disengage it from the middle holder. Pull it and slide it upward to remove the card from the in.yt enclosure.

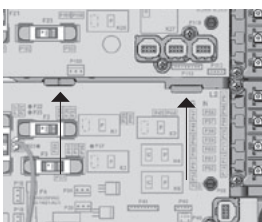

Put the new PCB back in the enclosure. Slide it downward, at an incline, behind the heater assembly. Then push it back, just underneath the middle PCB holder, and slide it upward. Install the

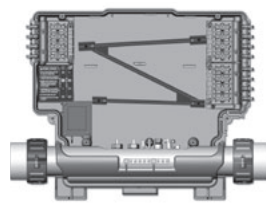

2 green ground screws. Be sure the circuit board is lying flat on the back of the enclosure. Put the in.link bracket back in place and secure it with the 2 screws. Be sure the locating pin is fully in the PCB hole.

Install the shroud around the heater's connection posts. Reinstall the AMP assembly bracket. Put the strain relief bracket in place. Plug the topside and in.link cables back in. Plug the output power cord in its initial location. Screw the strain relief cover in place. Reinstall the transformer connector. Plug the in.flo, the HL probe and temperature probe connectors back in. Plug the heater

connections back in: Return, Live, and Ground. Tighten the screws with a Phillips screwdriver. Connect the incoming power lines and tighten the terminal block screws firmly. Put the cover back in place and tighten the 6 screws.



## Step-by-step field replacement procedure

### How to replace the upper extension board on the in.yt

**Warning!**  
Before starting removal procedure be sure to:

- Turn off electric power to the unit.

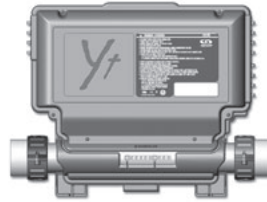

Using a Phillips screwdriver, loosen the 6 screws that hold the cover in place.

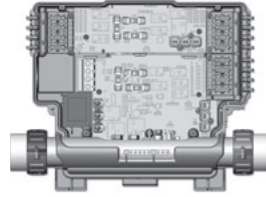

Identify each wire coming from the main board and remove them from the extension board.

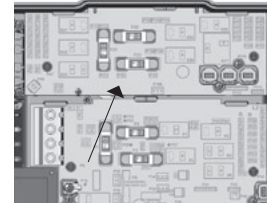

Remove the control cable from the upper board.

Disconnect the incoming conductors from the screw lug terminal.

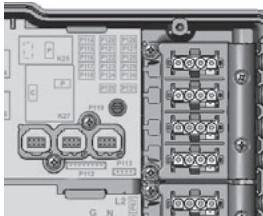

Remove the in.link cables. Identify and remove all the output power cord from the AMP assembly brackets left and right. Remove the strain relief covers, left and right, and remove cords. Do the same for the strain relief brackets. Remove screws from the AMP assembly brackets. Remove the 2 green grounding screws.

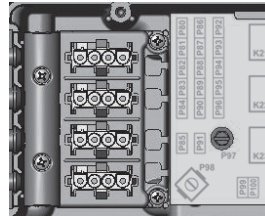

Remove the in.link bracket. Remove the screw from the bottom left side of the PCB. Slide the circuit board downwards to disengage it from the upper PCB holder tab. Put the new circuit board in place by engaging it into the PCB holder tab. Secure the board with the bottom lefthand side screw. Put the 2 green grounding screws back in place. Reinstall the in.link bracket with its 2 screws.

Reinstall the 2 AMP assembly brackets and the strain relief brackets. Put all of the output power cords back in place and secure them by reinstalling the strain relief covers. Plug the in.link cables and control cables from the main board back in. Reinstall all the remaining conductors coming from the main control board.

Reconnect the incoming conductor to the screw lug terminal. Reinstall the cover and secure it with the 6 screws.



## Specifications

### Environmental ratings:

Operating temperature:	32°F (0°C) to 136°F (58°C)
Storage temperature:	-13°F (-25°C) to 185°F (85°C)
Humidity:	Up to 85% RH, non condensing
IPx5 level of waterproofing	

### Mechanical:

#### in.ye

Weight:	Up to 9.7 lbs (4.4 kg)
Dimensions (W x H x D):	19.598" x 10.75" x 4.98" (497 x 273 x 126 mm)

#### in.yt

Weight:	Up to 12 lbs (4.45 kg)
Dimensions (W x H x D):	19.58" x 14.5" x 5.1" (497 x 368 x 130 mm)

### Model Y Series UL/CSA electrical specifications

Input rating:	120/240 V nominal (+5/-10%) (2 lines required with neutral) 48 A Max,
or (in.ye-3 only):	120 V nominal only (+5/-10%) (single line with neutral) 16 A Max, 60 Hz nominal (+1.5 / -1.0 Hz)

#### Heat.wav rating:

Voltage:	120 or 240 V, 60Hz
Wattage:	4 kW at 240 V, 1 kW at 120 V (Also available: 5.5 kW at 240 V)
Flow rate:	Minimum of 18 GPM (68 LPM) is required

UL 1563 Sixth Ed.

UL File: E182156

CSA No. 22.2 - 218.1-M89.



### Model Y Series TUV electrical specifications

Input rating:	230/240 V nominal (+5/-10%) (2-phase system with neutral) 20 A Max per phase, (3-phase system with neutral) 16A Max per phase.
or (in.ye-3 only):	240 V nominal only (+5/-10%) (single-phase system with neutral) 48 A Max, 50 Hz nominal (+1.5 / -1.0 Hz)

#### Heat.wav rating:

Voltage:	240 V, 50Hz
Wattage:	3.8 kW at 230 V 2.8 kW at 230 V
Flow rate:	Minimum of 18 GPM (68 LPM) is required

EN/IEC 60335 - 2 - 60/A2: 2008 - EN/IEC 60335 - 1: 2010

EN55014-1

EN55014-2

EN61000-3-2

EN61000-3-3





# Specifications

## North American Models

Device	Voltage	Maximum current	ye-3 <sup>*1</sup>	ye-5	yt-7 <sup>*7</sup>	yt-12 <sup>*8</sup>
Pump 1 (2-spd)	120 or 240 V	15 FLA/60 LRA (inrush)	●	●	●	●
Pump 2 (2-spd)	120 or 240 V	15 FLA/60 LRA (inrush)	● <sup>*2</sup>	● <sup>*4</sup>	●	●
Pump 3 (2-spd)	120 or 240 V	15 FLA/60 LRA (inrush)		● <sup>*5</sup>	●	●
Pump 4 (2-spd)	120 or 240 V	15 FLA/60 LRA (inrush)				●
Pump 5 (1-spd)	120 or 240 V	15 FLA/60 LRA (inrush)				●
O3/CP	120 or 240 V	6 FLA/10 A	● <sup>*3</sup>	●		●
A1	120 or 240 V	15 FLA/60 LRA (inrush)				●
Blower	120 or 240 V	15 FLA/60 LRA (inrush)				●
CP	120 or 240 V	6 FLA/10 A			●	●
O3	120 or 240 V	6 FLA/10 A			●	●
Direct out 1	120 or 240 V	10 A (always on)		● <sup>*6</sup>	●	●
Direct out 2	120 or 240 V	10 A (always on)			●	●

\*1 This model can be converted to a dedicated 120 V model.

\*2 Pump #2 can only be installed if Pump #1 is a single-speed pump.

\*3 Total of Pump #1-low (or Pumps #2) and O3/ CP cannot exceed 15 FLA.

\*4 Total of Pump #2 and Pump #3 cannot exceed 22 FLA.

\*5 Pump #3 can only be installed if Pump #2 is a single-speed pump.

\*6 Total of Pump #1-low, O3/ CP, and Direct #1 cannot exceed 15 FLA.

\*7 If CP is used, Pump 3 must be 1-speed  
 Total of pump 1-low, O3 and Di1 must not exceed 15 FLA  
 Total of P3, CP, and Di2 must not exceed 15 FLA

\*8 If A1 is used, Pump 4 must be 1-speed  
 Total of O3 and Di1 must not exceed 15 FLA  
 Total of P3, CP, and Di2 must not exceed 15 FLA  
 Total of P5, and B must not exceed 15 FLA  
 Total of P4, and A1 must not exceed 20 FLA



# Specifications

## European Models

Device	Voltage	Maximum current	ye-3*	ye-5	yt-7 <sup>*6</sup>	yt-12 <sup>*7</sup>
Pump 1 (2-spd)	230 V	15 FLA/60 LRA (inrush)	●	●	●	●
Pump 2 (2-spd)	230 V	15 FLA/60 LRA (inrush)	● <sup>*1</sup>	● <sup>*3</sup>	●	●
Pump 3 (2-spd)	230 V	15 FLA/60 LRA (inrush)		● <sup>*4</sup>	●	●
Pump 4 (2-spd)	230 V	15 FLA/60 LRA (inrush)				●
Pump 5 (1-spd)	230 V	15 FLA/60 LRA (inrush)				●
O3/CP	230 V	6 FLA/10 A	● <sup>*2</sup>	●		●
A1	230 V	15 FLA/60 LRA (inrush)				●
Blower	230 V	15 FLA/60 LRA (inrush)				●
CP	230 V	6 FLA/10 A			●	●
O3	230 V	6 FLA/10 A			●	●
Direct out 1	230 V	10 A (always on)		● <sup>*5</sup>	●	●
Direct out 2	230 V	10 A (always on)			●	●

\*1 Pump #2 can only be installed if Pump #1 is a single-speed pump.

\*2 Total of Pump #1-low (or Pumps #2) and O3/CP cannot exceed 20 FLA.

\*3 Total of Pump #2 and Pump #3 cannot exceed 20 FLA.

\*4 Pump #3 can only be installed if Pump #2 is a single-speed pump.

\*5 Total of Pump #1-low, O3/CP, and Direct #1 cannot exceed 20 FLA.

\*6 If CP is used, Pump 3 must be 1-speed  
 Total of pump 1-low, O3 and Di1 must not exceed 20 FLA  
 Total of P3, CP, and Di2 must not exceed 20 FLA

\*7 If A1 is used, Pump 4 must be 1-speed  
 Total of O3 and Di1 must not exceed 20 FLA  
 Total of P3, CP, and Di2 must not exceed 20 FLA  
 Total of P5, and B must not exceed 20 FLA  
 Total of P4, and A1 must not exceed 20 FLA



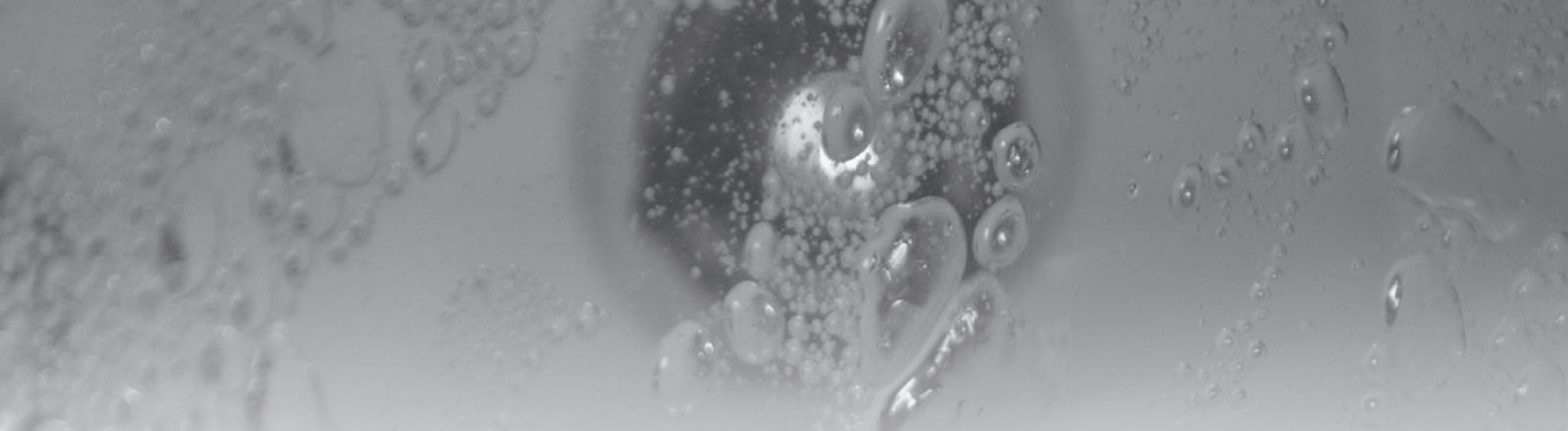

9919-101184-C  
Rev. 04-2014

© Groupe Gecko Alliance Inc., 2014  
All trademarks or registered trademarks  
are the property of their respective owners.

**Gecko Alliance**  
450 des Canetons, Quebec City (Qc), G2E 5W6 Canada, 1.800.78.GECKO  
9225 Stellar Court, Corona, CA 92883 USA, 951.667.2000

[www.geckoalliance.com](http://www.geckoalliance.com)

Printed in Canada