

# MSPA-MP METAPACK SERVICE MANUAL

• Gecko Electronics Inc. •

Visual step-by-step guide to easily  
identify & correct technical problems!



# Table of Contents

## Power & Ground Check

Tools and Parts	3
Electrical Wiring	4
GFCI Instructions & Flow Chart	5

## Programming

Jumper Positions	8
Low Level Programming	9

## Error Conditions

3 Flashing Dots Appearing On Keypad Display	11
3 Flashing Dots & LED Displayed	15
Display Is Flashing	19
Wrong Temperature Appearing On Keypad Display	23
FLO	25
FLC	29
Prr	31
HL	33
Smart Winter Mode	37

## Troubleshooting

Nothing Seems to Work!	39
Spa Does Not Heat!	43
Pump 1/Pump 2 Does Not Work!	47
Blower Does Not Work!	53
Light Does Not Work!	57
Ozonator Does Not Work!	59
Circulation Pump Does Not Work!	61
Keys Do Not Work!	63

## How to ...

Replace The Board	65
Replace The Heater (Horizontal Front/Back; Vertical/Side)	67
Install a Laing Heater	73
Adjust The Pressure Switch	76

## Miscellaneous

Parts List	78
Wiring Diagrams	80
Professional Repair Kit Info	82

*Note: For spa repairs and troubleshooting with Pocket-tek technology, please refer to Pocket-tek User's Manual available from Gecko and at [www.pocket-tek.com](http://www.pocket-tek.com).*



---

In an attempt to make this manual as useful as possible, it has been presented in two formats. Problem-solving solutions are described with Troubleshooting Flow Charts and also with Step-by-Step Procedures.

The two formats together should provide an overall complete explanation, with flow charts providing an overview of specific problems, and step-by-step procedures giving more detailed information.

### **Important Safety Information**

**WARNING:** Risk of electrical shock! All procedures described in this service manual must only be performed by qualified personnel, in accordance with the standards applicable in the country of installation and, whenever possible, with the equipment powered off. When connecting the equipment, always refer to the wiring diagram affixed to the inside of your spa pack's power box cover! This diagram always prevails over the wiring diagram at the end of this manual.

---

*All information given subject to technical modifications without notice.*

---

## Tools & Parts

The tools, test equipment and components needed to carry out MSPA-MP Metapack service calls.

### Required tools:



Pliers  
Phillips & flat screwdrivers  
1<sup>1</sup>/<sub>32</sub>" nut driver  
1/4" open end wrench

3/8" open end wrench  
Jumper cable  
Multimeter  
GFCI tester & digital thermometer (optional)

### Required pack parts:

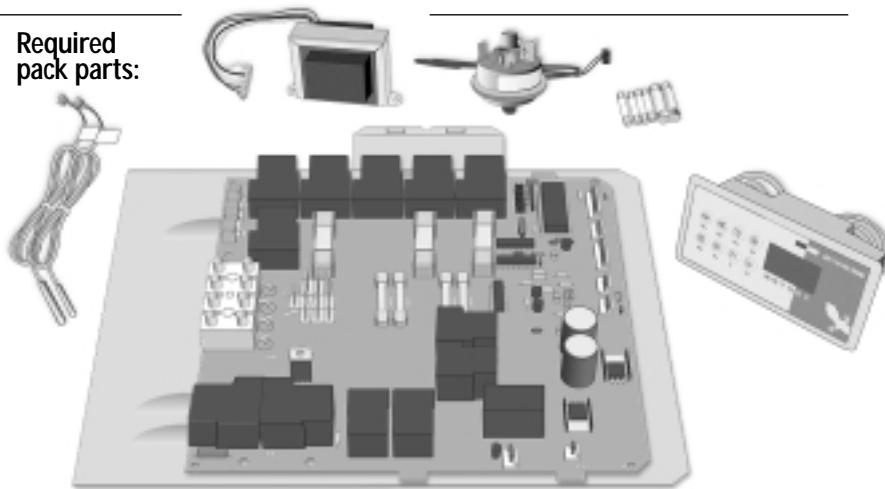

Regulation sensor  
Hi-Limit sensor  
MSPA-MP system board  
(or complete spa pack)

Transformer  
Pressure switch  
Fuses  
Top side control (keypad)

Gecko Electronics Inc. sells Professional Repair Kits that include everything needed for MSPA-MP Metapack servicing. For more information, go to the last page of this manual.

# Electrical Wiring

*Correct wiring of the electrical service box, GFCI box and pack terminal block is essential.*

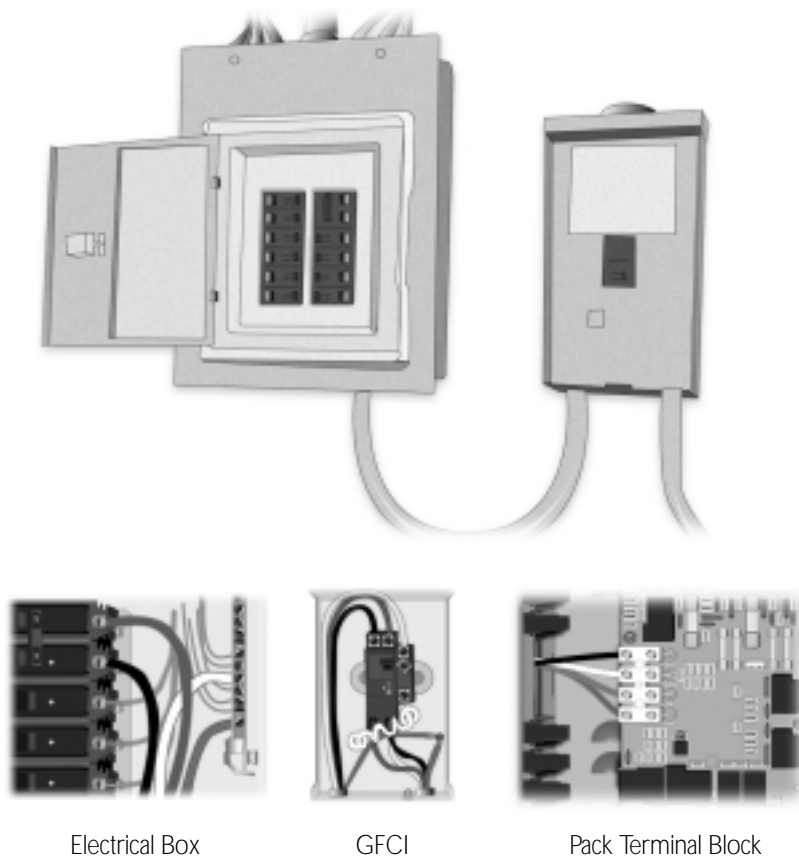

- 1 • Carry out a visual inspection to check for signs of miswiring.

Refer to supplied wiring diagrams.  
Call an electrician if necessary.

# GFCI Flow Chart

If GFCI trips, follow Troubleshooting Flow Chart below to identify the problem:

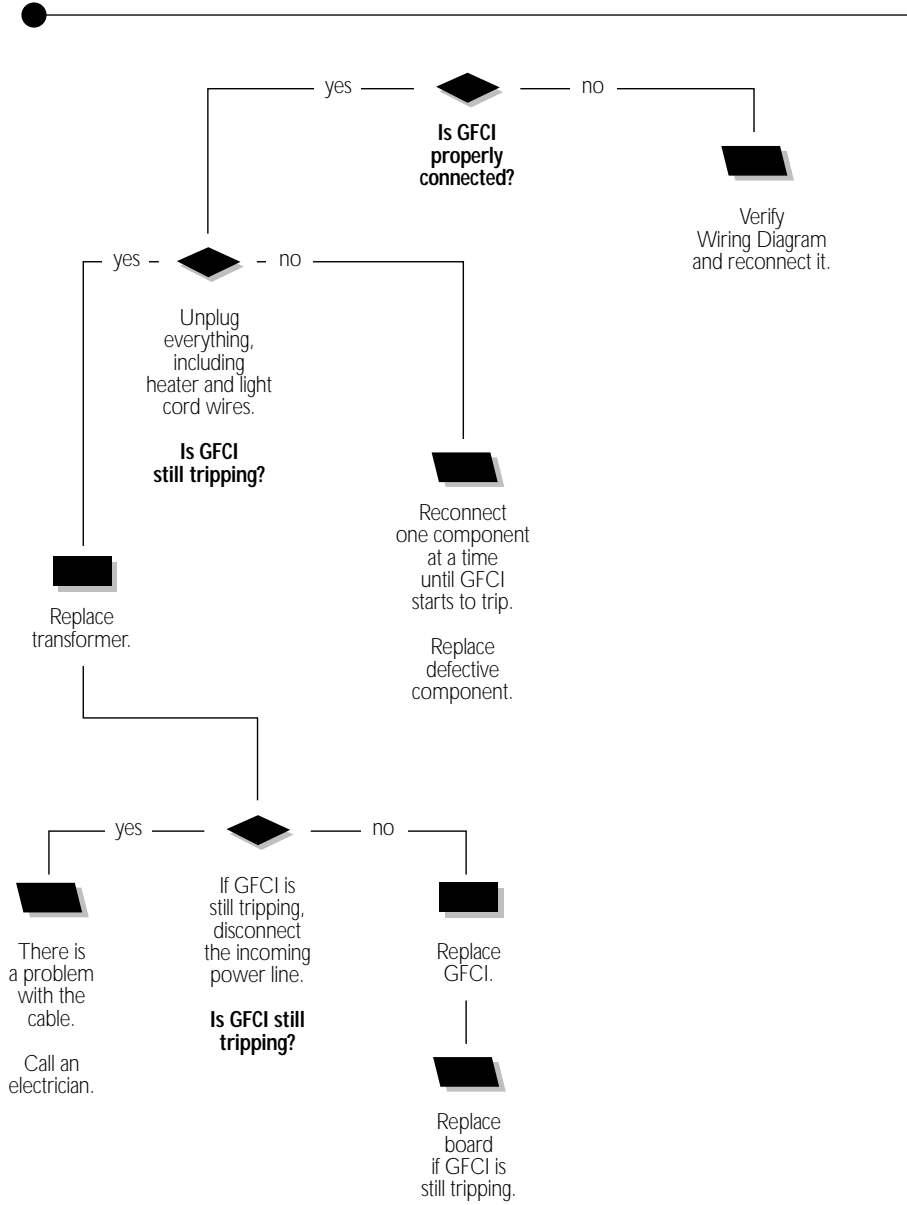

# GFCI Trips!

*If all connections are made, but nothing seems to be working, you probably have a power supply problem. Carry out the following tests to identify and correct the problem:*

**Note that for new installations, GFCI trippings due to miswiring are common.**

**If breaker is wired properly, GFCI trippings may occur when total amount of current drawn by spa exceeds breaker rating. This is highly unlikely as each spa pack output is individually fused, and fuses will blow before GFCI trips.**

**A current leak to ground will also cause GFCI to trip. If any of the components is faulty and a leak of more than 5mA occurs, GFCI will trip to prevent electrocution.**

**There are different GFCI models on the market. Note that illustrations are examples only.**

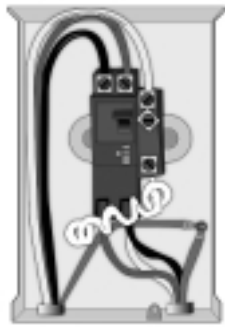

- 1 • Verify if GFCI is properly connected.

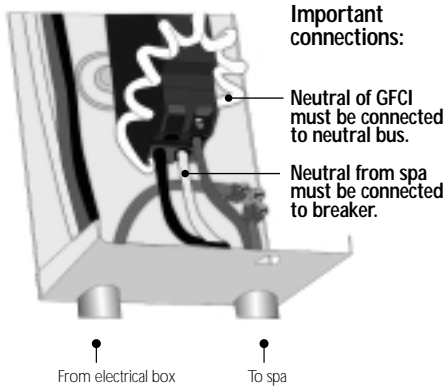

- 2 • If it is not, verify GFCI wiring diagram and reconnect it.



- 3 • If GFCI is properly connected, but still tripping, unplug all outputs including heater and light cord wires.

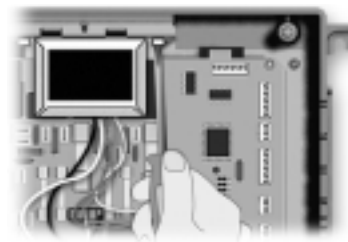

- 4 • If GFCI still trips, replace transformer.

If it stops tripping, reconnect one component at a time until GFCI starts to trip. Replace defective component.

## GFCI Trips!

*If GFCI continues to trip even after having replaced the transformer, carry out the following tests to correct the problem:*

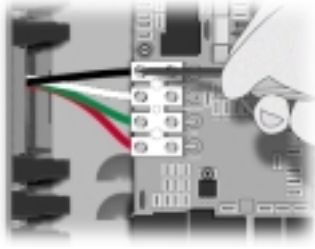

- 1• Disconnect incoming power lines.

If GFCI still trips, there must be a cable problem.

**Call an electrician!**

- 2• If GFCI stops tripping, replace GFCI.
- 3• If GFCI trips again, replace board. (Refer to "How to Replace the Board" section of this manual.)



# Jumper Positions

*Certain MSPA-MP spa pack parameters can be modified by changing the position of jumpers on the board.*

Remove MSPA-MP power box cover to access jumpers. (See "How to Replace the Board" section of this manual). Jumper functions may differ from information below. Please check wiring diagram on inside pack cover to verify specific functions for our pack.

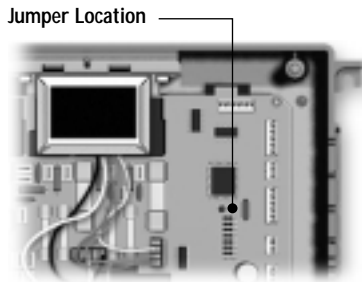

- 1• Jumpers are located in upper right side of the board.

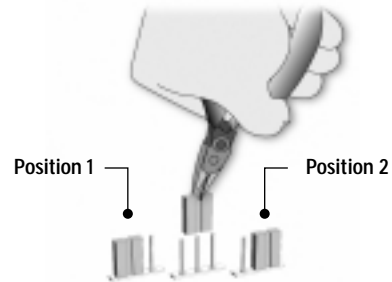

- 2• To change a setting, simply pull cover off and replace in desired position.

## Jumper 1: Current Limiting Option

Jumper 1 is used to limit amount of current drawn when more than one pump (or pump and blower) are on at the same time.

### Position 1 (HC):

Heater will shut down if more than one pump is on at high speed.

### Position 2 (LC):

The system will not turn heater on if any pump (1, 2 or 3) is on at high speed.

"Heater" indicator will flash on display indicating that more heat is requested, but heater will not be allowed to start.

## Jumper 2: Keypad Configuration

### Position 1:

10-key configuration.

### Position 2:

8-key configuration.

# Low Level Programming

*Certain system operating parameters can be configured from the keypad. This is normally done by Gecko or the spa installer, but may be done any time.*

## Low level programming:

To access low level programming, press and hold **On/Off** key for 20 seconds, after which the first parameter code should appear on the display.

Use **Up/Down** keys to modify parameter values and **On/Off** key to change from one parameter to the next. You must go through all parameters to exit this mode. If you do not wish to change a parameter, simply press **On/Off** key to advance to the next parameter.

## List of parameter configurations

### 1- Pump 1

Display: P1 x  
Value of x: 1 = single-speed  
2 = two-speed

### 2- Pump 2

Display: P2 x  
Value of x: 0 = not installed  
1 = single-speed  
2 = two-speed

### 3- Pump 3

Display: P3 x  
Value of x: 0 = not installed  
1 = installed

### 4- Blower

Display: bL x  
Value of x: 0 = not installed  
1 = single-speed  
2 = two-speed  
3 = three-speed

### 5- Light

Display: LI x  
Value of x: 0 = not installed  
1 = 12 VAC (single-intensity)  
2 = 12 VAC (triple-intensity)  
3 = 120 VAC (single-intensity on auxiliary 1 relay)  
4 = Internal fiber box control mode (2-aux. relay)

### 6- Ozone

Display: O3 x  
Value of x: 0 = not installed  
1 = on only in filter cycle  
2 = always on  
3 = on with circ. pump

### 7- Circulation pump

Display: CP x  
Value of x: 0 = not installed  
1 = regulated (with spa temperature)  
2 = always on  
3 = on, except if 2 degrees over set point

### 8- Filter cycle

Display: FC x  
Value of x: 0 = filter cycle enabled  
2 = filter cycle disabled  
1 = filter cycle replaced by purge cycle

### 9- Pressure switch status

Display: PS x  
Value of x: 0 = with Pump 1  
1 = with circ. pump  
(CP cannot be set to 0)



# Flashing Dots Flow Chart

If 3 flashing dots appear on keypad display, follow Troubleshooting Flow Chart below to identify the problem:

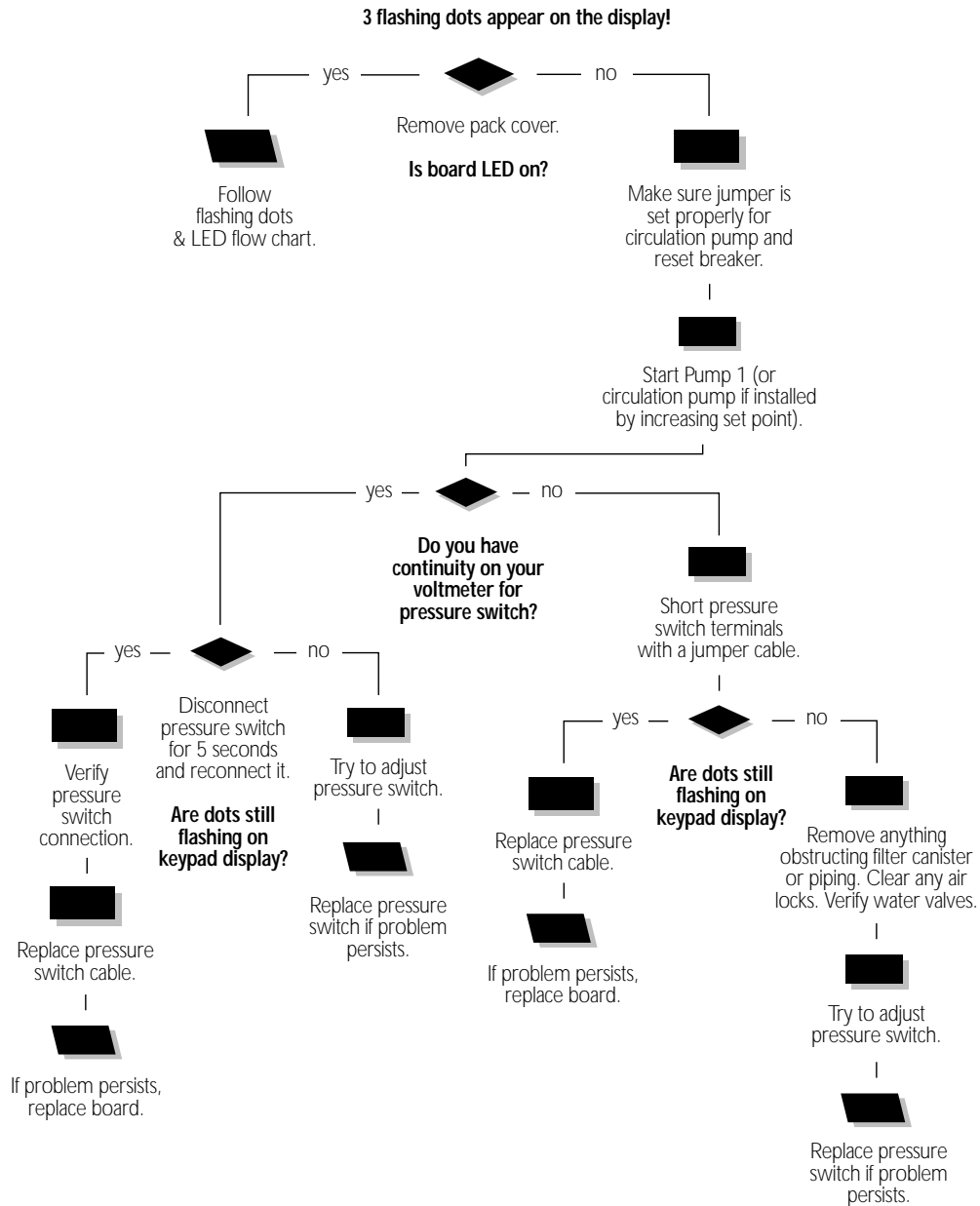

## Flashing Dots Displayed

*Three flashing dots error condition indicates a pressure switch problem.*

**There must be enough water in the spa for normal operations. System may detect error condition if spa filter is dirty or if something restricts flow of water in piping.**

**The heater will automatically shut down when error condition occurs.**

**Power may remain On when the following steps are carried out.**

- 1• Verify if Pump 1 (or circulation pump if installed) is working. If pump is not working right, refer to pump section of this manual.
- 2• Make sure jumper is set properly for circulation pump.
- 3• If Pump 1 is working properly, turn it on by pressing **Pump 1** key (or start circulation pump by increasing the set point) and test continuity on pressure switch.
- 4• If you detect continuity, go to step #10.
- 5• If you do not detect continuity, verify if pressure switch cable is properly connected to pressure switch and board.

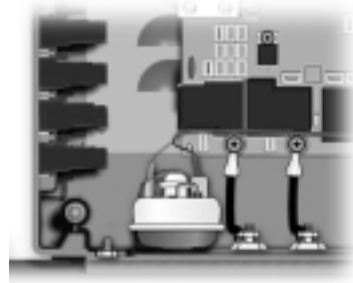

## Flashing Dots Displayed

- 6• Ensure adequate water flow in the heater and short two pressure switch terminals with jumper cable.

- 7• **If the three dots disappear**, first make sure there is no blockage of water or air lock and check water valve.

If the installation is older than 2 years, replace the pressure switch and recalibrate it.

If installation is recent, try readjusting the pressure switch. If this is not possible, replace switch.

(Refer to "How to Adjust the Pressure Switch" section of this manual.)

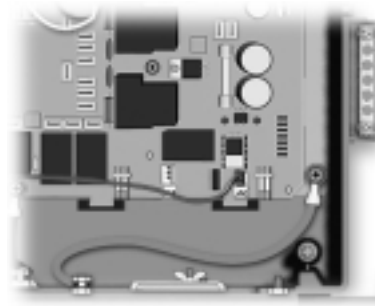

- 8• **If the three dots still appear**, the problem may be either with switch cable or board.

Remove plastic cover and replace cable.

- 9• Replace board if error condition still persists. (Refer to "How to Replace the Board" section.)

## Flashing Dots Displayed

Power may remain On while the following steps are carried out.

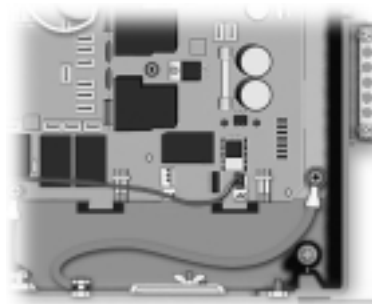
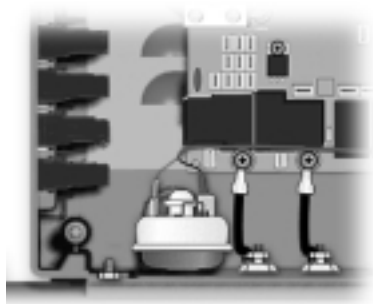

- 10• If you have continuity on pressure switch, follow these steps:

Disconnect pressure switch cable for 5 seconds and reconnect it.

**If error condition disappears**, adjust pressure switch, if it is a new installation (less than two years) or replace it.

(Refer to "How to Adjust the Pressure Switch" section of this manual.)

- 11• If error condition persists, remove plastic cover and replace pressure switch cable.
- 12• Replace board if error condition still persists. (Refer to "How to Replace the Board" section of this manual.)

# Flashing dots and LED Flow Chart

If error condition occurs (potential Hi-Limit sensor or temperature probe problem), follow Troubleshooting Flow Chart below to identify the problem:

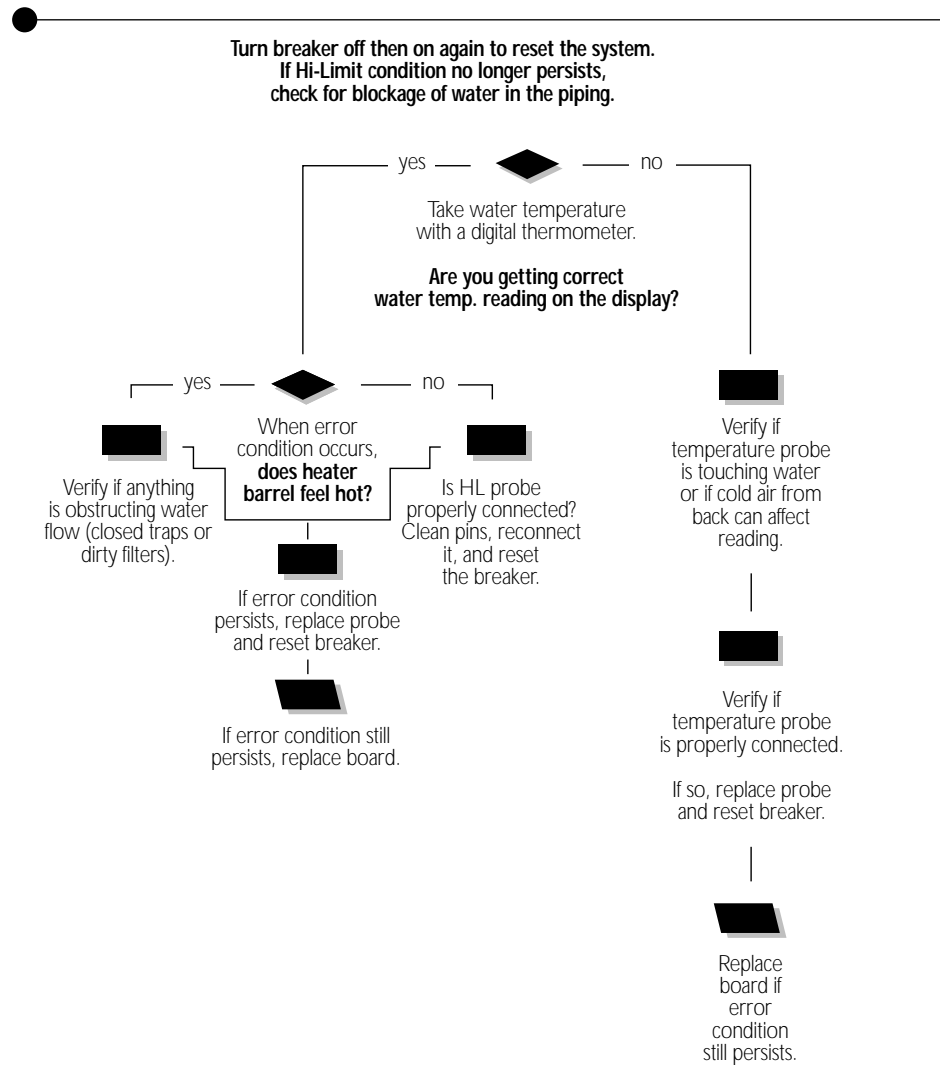



## Flashing Dots & LED Displayed

*The three flashing dots and LED error condition is related to the Hi-Limit sensor or temperature probe.*

**Turn breaker off then on again to reset the system.  
If 3 flashing dots and LED disappear, wait until they are displayed again on keypad.  
Power may remain On.**

- 1• Take water temperature with a digital thermometer.
- 2• **If keypad display shows correct temperature:**
  - a- Check if heater barrel feels hot.  
  
If it's hot, verify if anything is obstructing the flow of water (closed valves or dirty filter).
  - b- If it's not, verify if hi-limit probe is properly connected.
  - c- If error condition persists, replace probe and reset breaker.
  - d- If problem is not corrected, replace board. (Refer to "How to Replace Board" section of present manual.)
- 3• Proceed to following page if keypad display shows incorrect temperature.

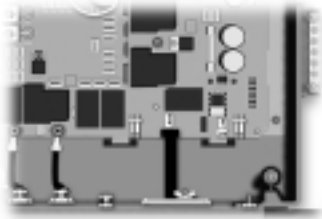

Try to clean probe connector pins. Even a small coating of film can cause a bad connection. Reconnect probe and reset breaker.

## Flashing Dots & LED Displayed

*If keypad display isn't showing correct temperature, carry out the following tests:*

- 1• Verify if temperature probe is in contact with water and if cold air from the back could be affecting readings.

Use foam to isolate probe from cold air if that is the problem.



- 2• Make sure temperature probe is properly connected.  
If it is, replace probe and reset breaker.
- 3• Replace board if error condition still persists. (Refer to "How to Replace the Board" section of this manual.)



# Display Flashing Flow Chart

On MSPA-MP-NE packs, if system detects temperature at 112°F or higher, the display will start flashing. Follow Troubleshooting Flow Chart below to identify the problem:

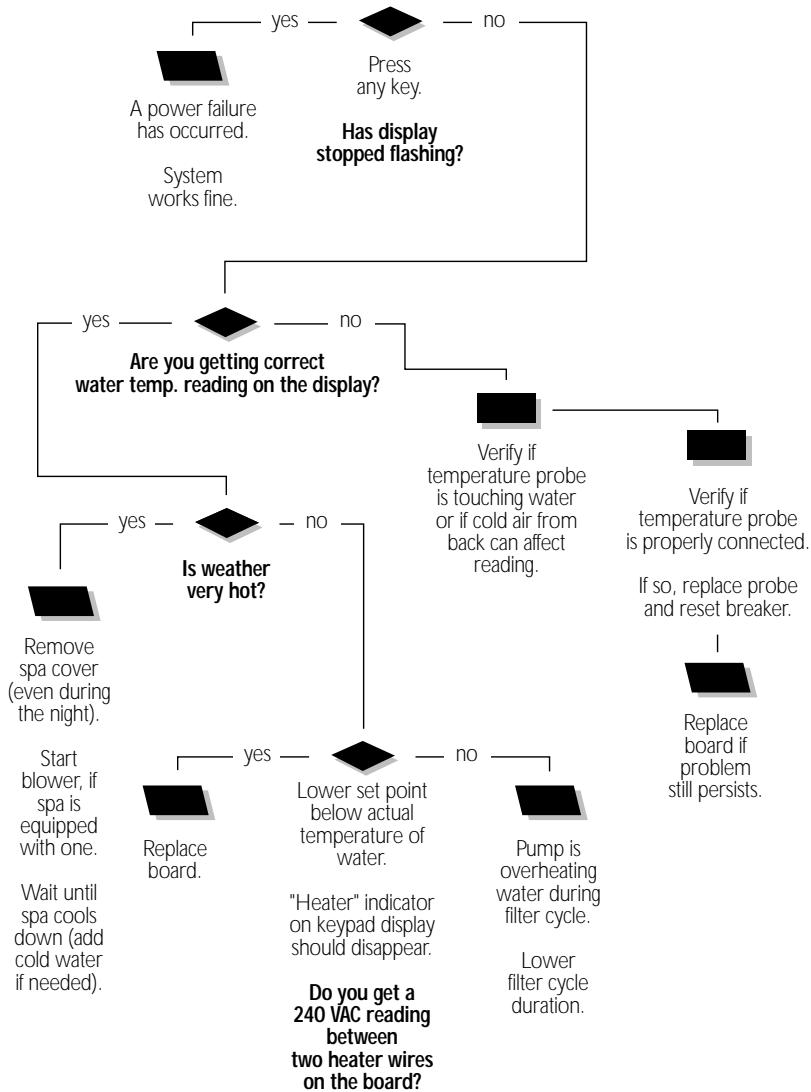

## Display Is Flashing

*If digital thermometer water temperature reading is 112°F or higher and keypad display indicates correct temperature, carry out the following tests:*

**If display stops flashing after pressing a key, this means that a power failure has occurred. System works fine.**

### **If weather is very hot:**

- 1• Remove spa cover (even during the night). Start blower if spa is equipped with one. Wait until spa cools down (add cold water if necessary).

### **If hot weather is not a factor:**



- 2• Lower set point below current water temperature.

"Heater" indicator should disappear from keypad display.



- 3• Remove spa cover. With a volt-meter, read the voltage between the two heater wires on the board.

- 4• **If you do not read 240 VAC**, pump may be overheating water during filter cycle.

Enter Programming mode and shorten filter cycle duration.

- 5• **If you do read 240 VAC**, test the element. If it is opened, replace it. If element works fine, replace board.

(Refer to "How to Replace the Board" section of this manual.)

## Display Is Flashing

*If digital thermometer water temperature reading is 112°F or higher and keypad display isn't showing correct temperature, carry out the following tests:*

- 1• Verify if temperature probe is in contact with water and if cold air from the back could be affecting readings.

Use foam to isolate probe from cold air if that is the problem.



- 2• Make sure temperature probe is properly connected.

If it is, replace probe.

- 3• Replace board if display is still flashing.

(Refer to "How to Replace the Board" section of this manual.)



## Wrong Temperature Flow Chart

*On MSPA-MP-NE packs, if system detects that temperature is not within normal limits, wrong temperature will be displayed. Follow Troubleshooting Flow Chart below to identify the problem:*



Check if regulation probe is properly connected.

|



Unplug probe connector and clean pins on the board (even a small coating of film may cause a bad connection).  
Reconnect the probe.

|



Replace probe with a spare and verify if problem is solved.

If it is, replace probe with spare.

|



Replace board if problem persists.



## Wrong Temperature Displayed

*Wrong temperature on keypad display indicates a problem with regulation sensor. The system is constantly verifying if temperature probe reading is within normal limits.*

**Note that water temperature must be over 35°F in order to carry out the following steps. Power can remain On.**



- 1 • Verify if regulation probe (sensor located in spa) is properly connected.



- 2 • Disconnect probe connector and clean probe connector pins. Even a small coating of film may cause a bad connection.

- 3 • Reconnect probe.

If wrong temperature is still displayed, replace probe with a spare and place probe head directly in spa water.

If problem is solved, replace probe.

- 4 • Replace board if problem persists.

# FLO Flow Chart

If FLO error condition occurs (problem with the pressure switch: pump is on but no water pressure detected), follow Troubleshooting Flow Chart below to identify the problem:

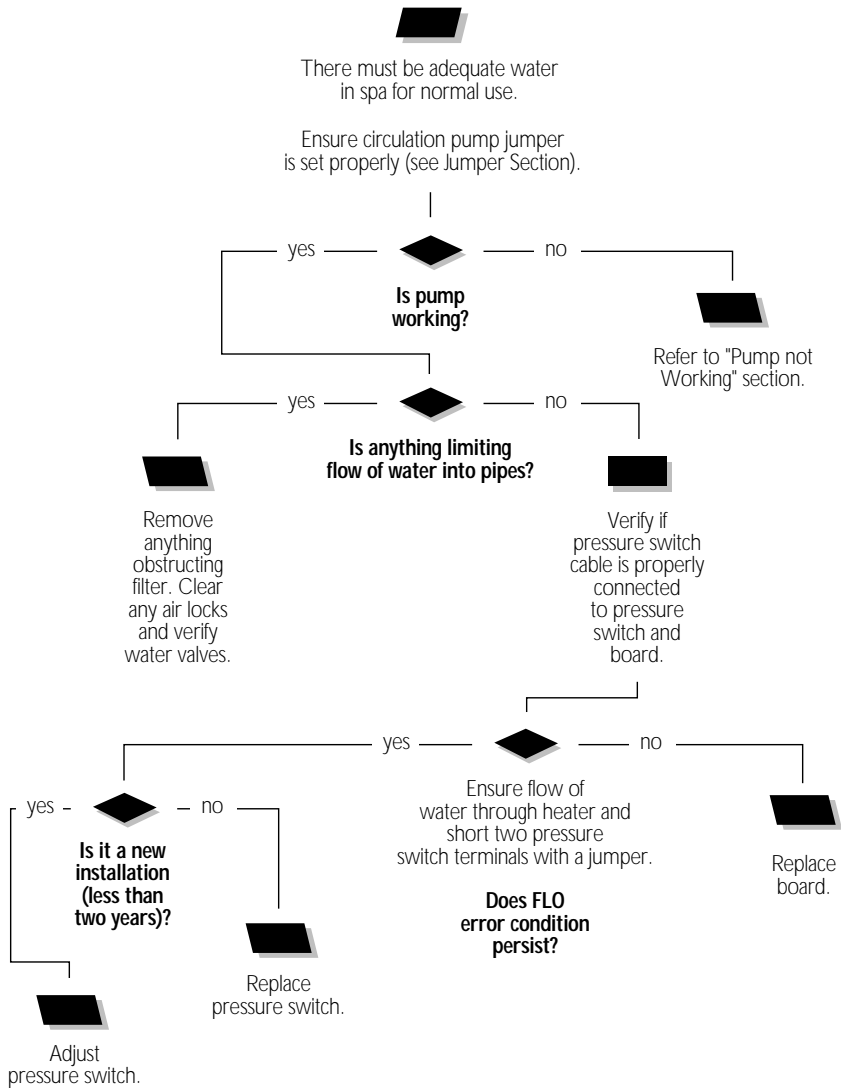

## FLO Error Condition

*An FLO error condition indicates a pressure switch problem. If system does not detect any pressure when pump is manually or automatically turned on, an FLO error condition will occur.*

**There must be enough water in the spa for normal operations. System may detect an FLO error condition if spa filter is dirty or if something restricts flow of water in piping.**

**The heater will automatically shut down when an FLO error condition occurs.**

**Power may remain On when the following steps are carried out.**

- 1• Verify if pump (or circulation pump if present) is working. If pump is not working right, refer to pump (or circulation pump) section of this manual.
- 2• Make sure jumper setting for circulation pump is correct. (See Jumper Section).
- 3• Clean filter and check for air blockages, closed trap valves or anything that could be restricting water flow.
- 4• Verify if pressure switch cable is properly connected to pressure switch and board.

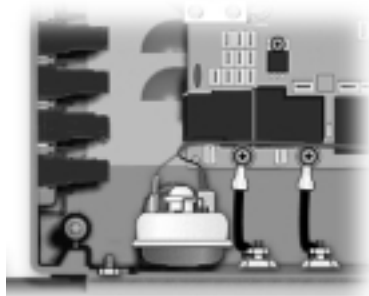

## FLO Error Condition

- 5• Ensure adequate water flow in the heater and short two pressure switch terminals with jumper cable.

- 6• **If FLO error condition disappears,** perform the following steps:

If the installation is older than 2 years, replace the pressure switch and recalibrate it.

If installation is recent, try readjusting the pressure switch. If this is not possible, replace switch.

(Refer to "How to Adjust the Pressure Switch" section of this manual.)

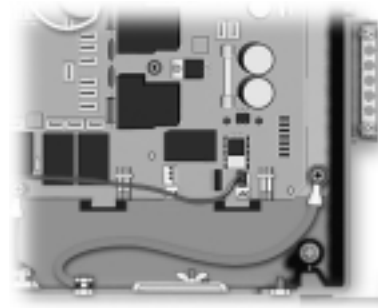

- 7• **If FLO error condition persists,** the problem may be either with switch cable or board.

Remove plastic cover and replace cable.

- 8• Replace board if FLO error condition still persists. (Refer to "How to Replace the Board" section.)



# FLC Flow Chart

If FLC error condition occurs, follow Troubleshooting Flow Chart below to identify problem (usually pressure switch problem - pump is off but water pressure is detected):

**First ensure jumper position for circulation pump is set correctly (see Jumper Section).**

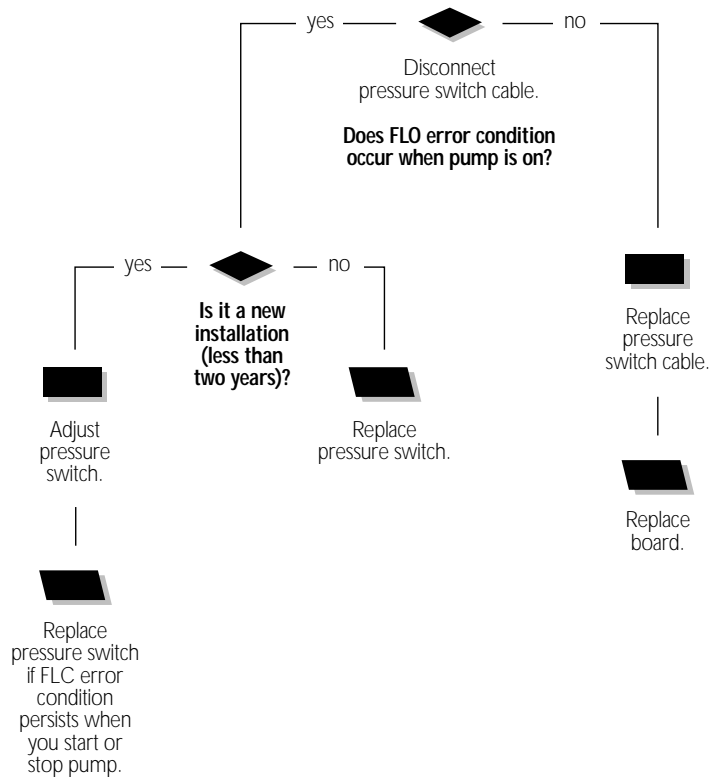

## FLC Error Condition

*An FLC error condition indicates a pressure switch problem. If the system detects any pressure when the pump is off, an FLC error condition will occur.*

Power may remain On while the following steps are carried out.

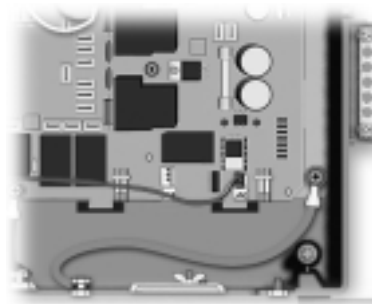
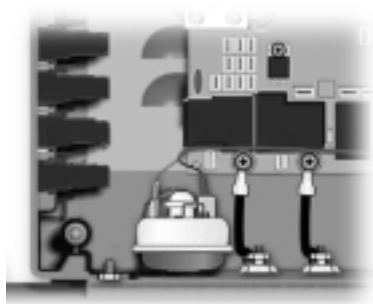

- 1• First check to ensure jumper position for circulation pump is set correctly (see Jumper Section). If not, readjust jumper.  
  
Disconnect pressure switch cable.
- 2• If FLO error condition occurs when pump is started, adjust pressure switch, if it is a new installation (less than two years) or replace it.  
  
(Refer to "How to Adjust the Pressure Switch" section of this manual.)
- 3• If there is no FLO error condition, remove plastic cover and replace pressure switch cable.
- 4• Replace board if FLC error condition still persists. (Refer to "How to Replace the Board" section of this manual.)

# Prr Flow Chart

*If Prr error condition occurs (potential regulation sensor problem), follow Troubleshooting Flow Chart below to identify the problem:*

**Pressing any key after each step resets the system.**



Note that water temperature must be over 35°F to operate spa.

In systems manufactured after 98, Prr error status is ignored during first hour after initial power up to allow water to heat to over 35°F.



Check if regulation probe is properly connected.



Unplug probe connector and clean pins on the board (even a small coating of film may cause a bad connection).  
Reconnect the probe.



Replace probe with a spare and verify if problem is solved.

If it is, replace probe with spare.



Replace board if problem persists.



## Prr Error Condition

*The Prr error condition indicates a problem with regulation sensor. The system is constantly verifying if temperature probe reading is within normal limits.*

**Note that water temperature must be over 35°F in order to carry out the following steps. Pressing any key after each step resets system. Power can remain On.**



- 1 • Verify if regulation probe (sensor located in spa) is properly connected.



- 2 • Disconnect probe connector and clean probe connector pins. Even a small coating of film may cause a bad connection.

- 3 • Reconnect probe.

If Prr error condition still persists, replace probe with a spare and place probe head directly in spa water.

If problem is solved, replace probe.

- 4 • Replace board if problem persists.

# HL Flow Chart

If HL error condition occurs (potential Hi-Limit sensor or temperature probe problem), follow Troubleshooting Flow Chart below to identify the problem:

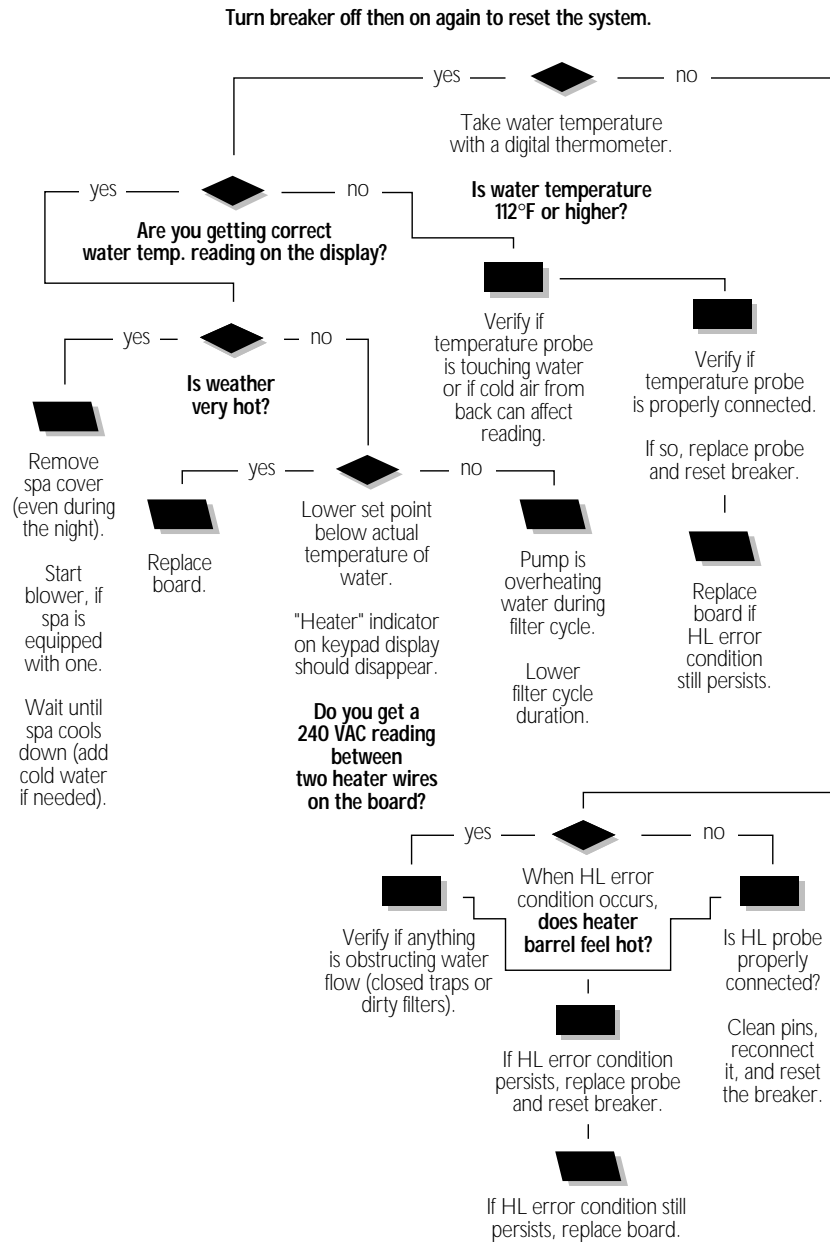

## HL Error Condition

*The HL error condition is related to the Hi-Limit sensor or temperature probe.*

**Turn breaker off then on again to reset the system. Power may remain On.**

- 1 • Take water temperature with a digital thermometer.
  - a- Check if heater barrel feels hot.  
If it's hot, verify if anything is obstructing the flow of water (closed valves or dirty filter).
  - b- If it's not, verify if hi-limit probe is properly connected.
  - c- If HL error condition continues to appear on display, replace probe and reset breaker.
  - d- If problem is not corrected, replace board. (Refer to "How to Replace Board" section of this manual.)
- 2 • **If reading is below 112°F**, HL error condition should be steady, indicating a problem at the hi-limit probe and heater level.
- 3 • **If reading is 112°F or higher**, HL error condition should flash, indicating a problem with temperature probe.

Proceed to following page if keypad display shows correct temperature.

Proceed to page 36 if display doesn't show correct temperature.

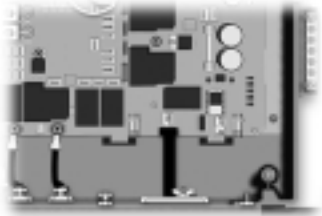

Try to clean probe connector pins. Even a small coating of film can cause a bad connection. Reconnect probe and reset breaker.

## HL Error Condition

*If digital thermometer water temperature reading is at 112°F or higher and keypad display indicates correct temperature, carry out the following tests:*

### If weather is very hot:

- 1• Remove spa cover (even during the night). Start blower if spa is equipped with one. Wait until spa cools down (add cold water if necessary).

### If hot weather is not a factor:



- 2• Lower set point below current water temperature.

The "Heater" indicator should disappear from keypad display.



- 3• Remove the plastic cover. With a voltmeter, read the voltage between the two heater wires on the board.

- 4• **If you do not read 240 VAC**, pump may be overheating water during filter cycle.



Enter Programming mode and shorten filter cycle duration.

- 5• **If you do read 240 VAC**, replace board. (Refer to "How to Replace the Board" section of this manual.)

## HL Error Condition

*If digital thermometer water temperature reading is at 112°F or higher and keypad display isn't showing correct temperature, carry out the following tests:*

- 1 • Verify if temperature probe is in contact with water and if cold air from the back could be affecting readings.

Use foam to isolate probe from cold air if that is the problem.



- 2 • Make sure temperature probe is properly connected.

If it is, replace probe and reset breaker.

- 3 • Replace board if HL error condition still persists. (Refer to "How to Replace the Board" section of this manual.)

## Smart Winter Mode Chart

If pumps have started up on several occasions and "Filter Cycle" indicator is flashing on keypad, follow this Troubleshooting Flow Chart to identify the problem:

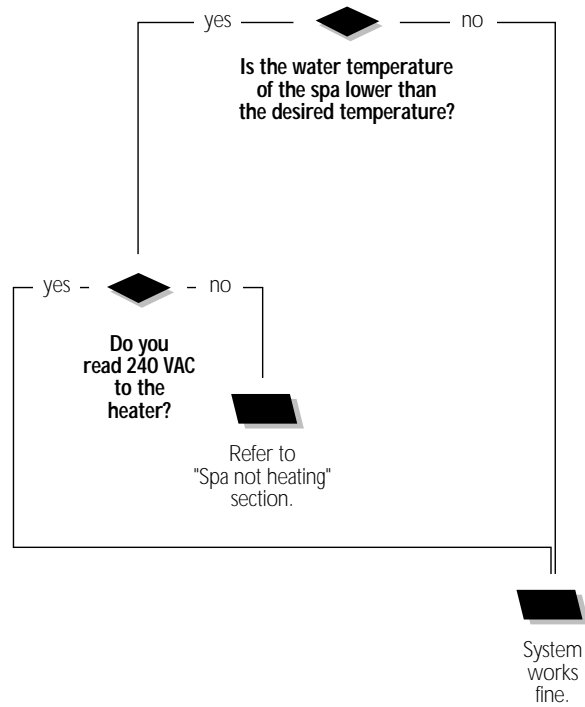

## Smart Winter Mode

*If pumps have started up several times and "Filter Cycle" indicator is flashing, the system has detected water cold enough to freeze the pipes and has gone into the protective Smart Winter Mode.*



An irregularly flashing "Filter Cycle" indicator means that the system has stopped filtering after 3 hours because water temperature exceeds set point by more than 2° F. If the temperature cools down before the scheduled end of the cycle, filtering will resume for the remainder of the programmed cycle duration.

- 1 • With a digital thermometer, verify the temperature of the water.

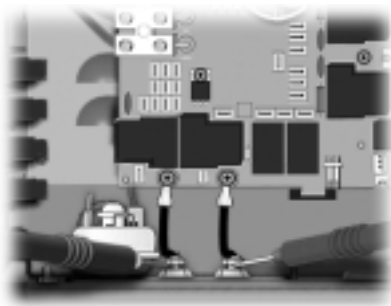

- 2 • If the water temperature is lower than the desired temperature, measure the voltage to the heater.

If your reading is approx.  $\approx 240$  VAC, Smart Winter Mode is working properly.

If you do not read  $\approx 240$  VAC, refer to the "Spa not heating" section of this manual.

# "Nothing Seems to Work" Flow Chart

If nothing seems to work, follow Troubleshooting Flow Chart below to identify the problem:

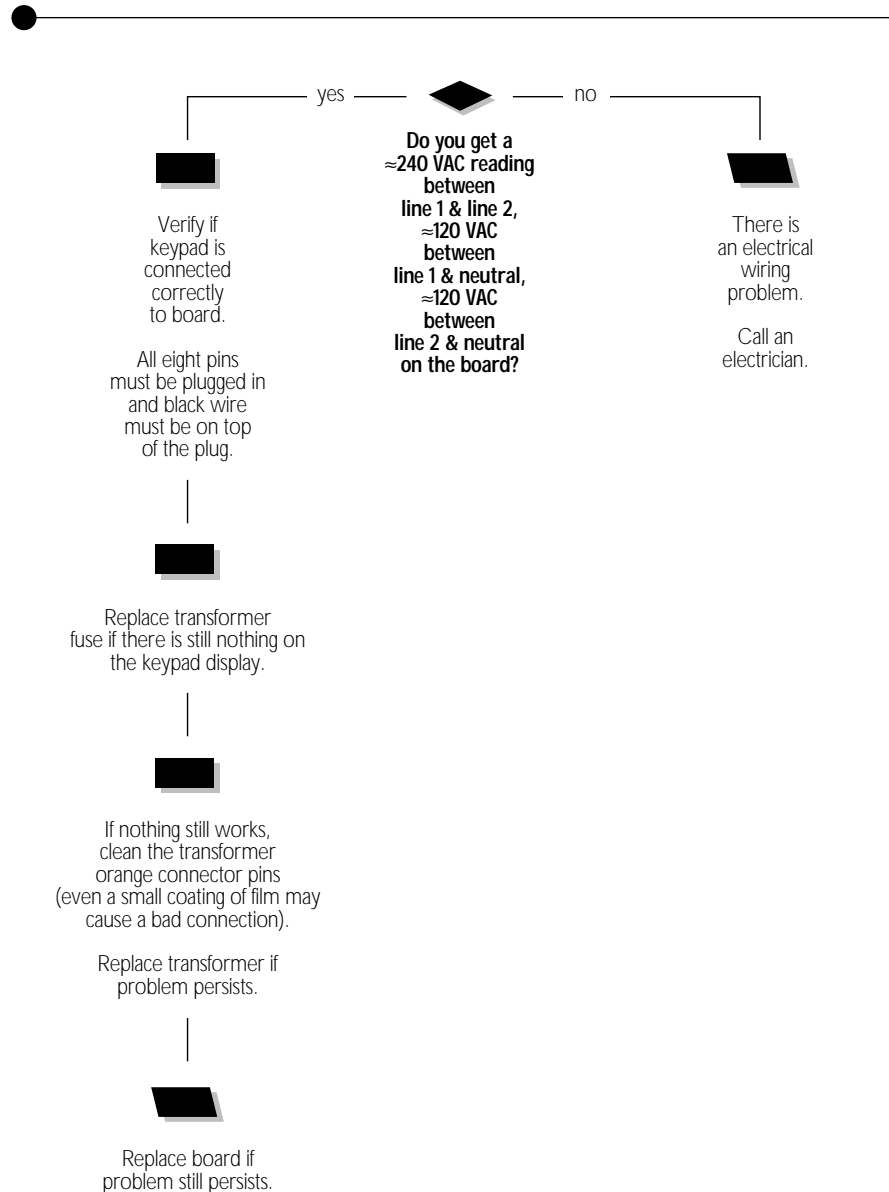



## Nothing Seems to Work!

*If everything is connected, but nothing seems to work, there is probably a power supply problem. Carry out the following tests to identify and correct the problem:*

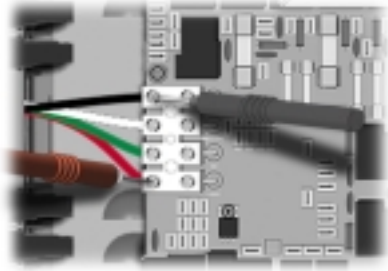

- 1• On the terminal block, measure voltage between line 1 and line 2.

You should get  $\approx 240$  VAC.

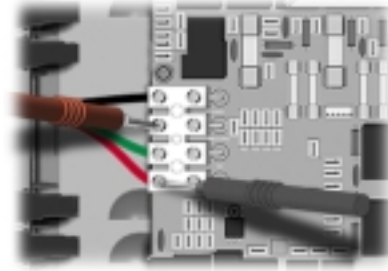

- 3• Measure voltage between line 2 and neutral.

You should get  $\approx 120$  VAC.

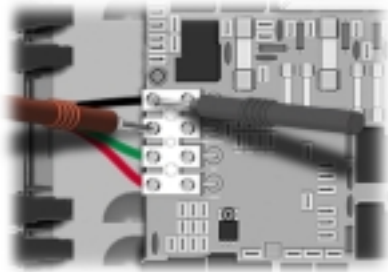

- 2• Measure voltage between line 1 and neutral.

You should get  $\approx 120$  VAC.

- 4• If you do not get good readings, this indicates an electrical wiring problem.

**Call an electrician!**

## Nothing Seems to Work!

*If you are getting good voltage readings, but nothing seems to work, carry out the following tests to correct the problem:*

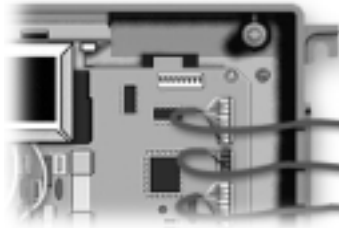

- 1 • Verify if keypad is correctly connected to the board.



- 3 • If nothing works, clean transformer orange connector pins. Even a small coating of film may cause a bad connection.

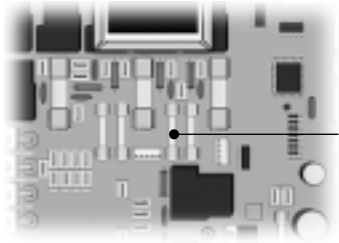

Xfo  
fuse

- 2 • Replace transformer fuse if nothing still seems to work.



- 4 • Replace transformer if problem persists.
- 5 • If problem is still not solved, replace board. (Refer to "How to Replace the Board" section.)



# "Spa Not Heating" Flow Chart

If the spa does not seem to be heating the water, follow Troubleshooting Flow Chart below to identify the problem:

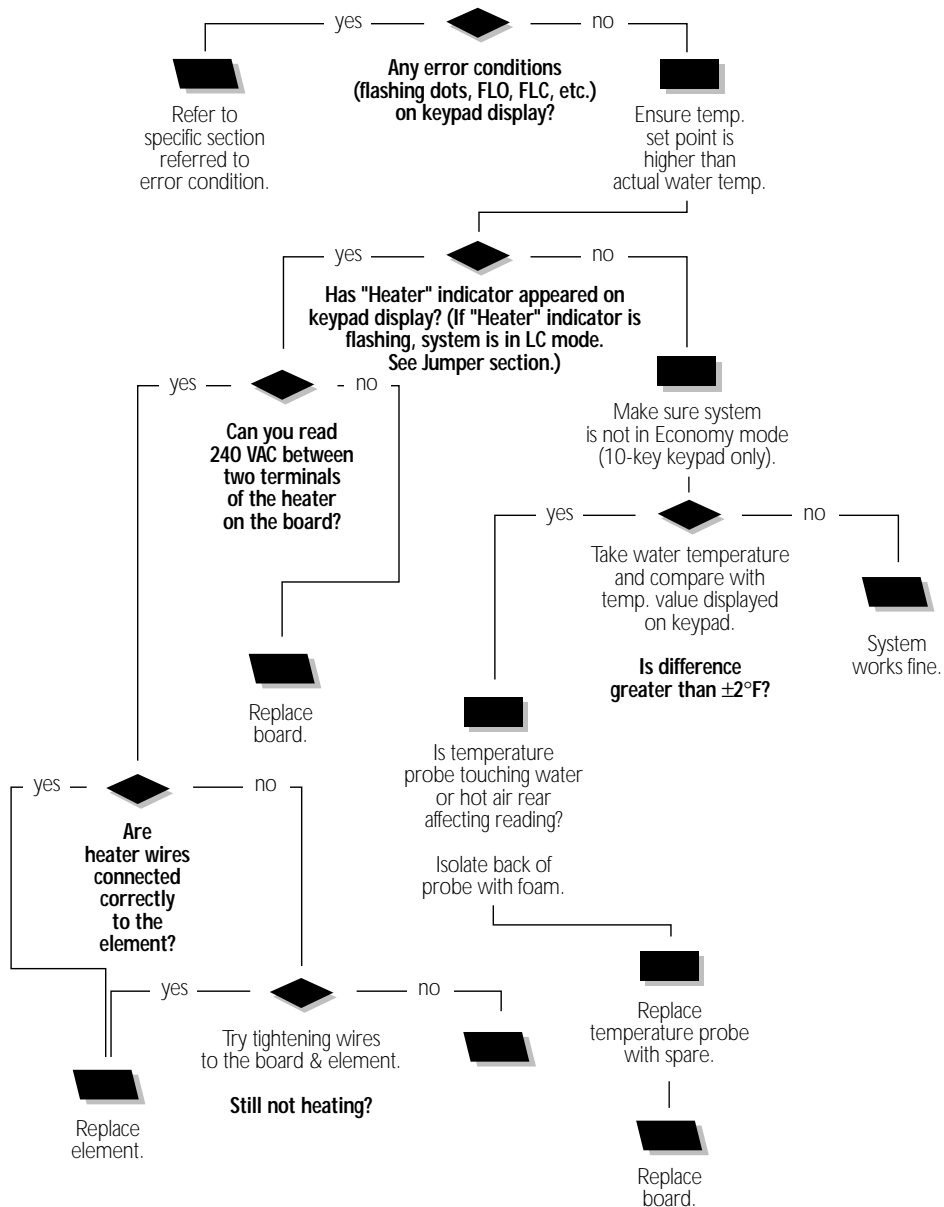

# Spa Not Heating!

If the spa does not appear to be heating the water, carry out the following tests to correct the problem:

1. Check for an error condition on keypad display. If there is one, refer to section indicated by the error condition.



2. If there is no error condition try to increase temperature by raising temperature set point. Press **Up** key to increase set point.

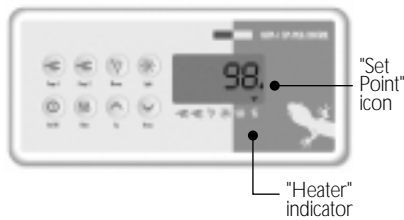

3. Verify if "Heater" indicator appears on the display.

"Heater" indicator will be on when heater is on. It will flash if more heat has been requested, but heater has not yet started or if system is in LC mode (see Jumper Section).

## If "Heater" indicator does not light up!

Make sure system is not in an Economy mode cycle (10-key keypad configuration only).

4. Use a digital thermometer to take water temperature and compare your reading with the temperature value on the keypad display.

If values are different ( $\pm 2^{\circ}\text{F}$ ), verify if sensor is touching water or if hot air from rear could be affecting readings.



5. If yes, use foam to isolate behind the probe.
6. If no, replace temperature sensor with a spare one.
7. If spa is still not heating, replace the board.

## Spa Not Heating!

If "Heater" indicator appears on the display, but spa is still not heating, carry out the following tests to correct the problem:

If "Heater" indicator lights up on the display:

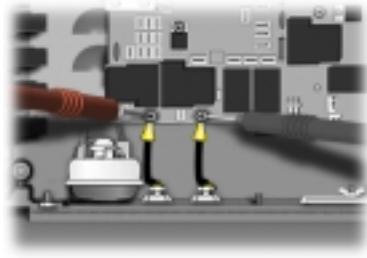

- 1 • Remove plastic cover and measure voltage between two heater screws on the board.  
  
Replace board if you are not getting a reading of  $\approx 240$  VAC.
- 2 • If voltage reading is correct, verify if heater wires are properly connected to the element.  
  
If not, tighten wires to board and element.
- 3 • If problem persists, replace the element.



# Pump Flow Chart

If Pump 1 or Pump 2 is not working, follow Troubleshooting Flow Chart below to identify the problem:

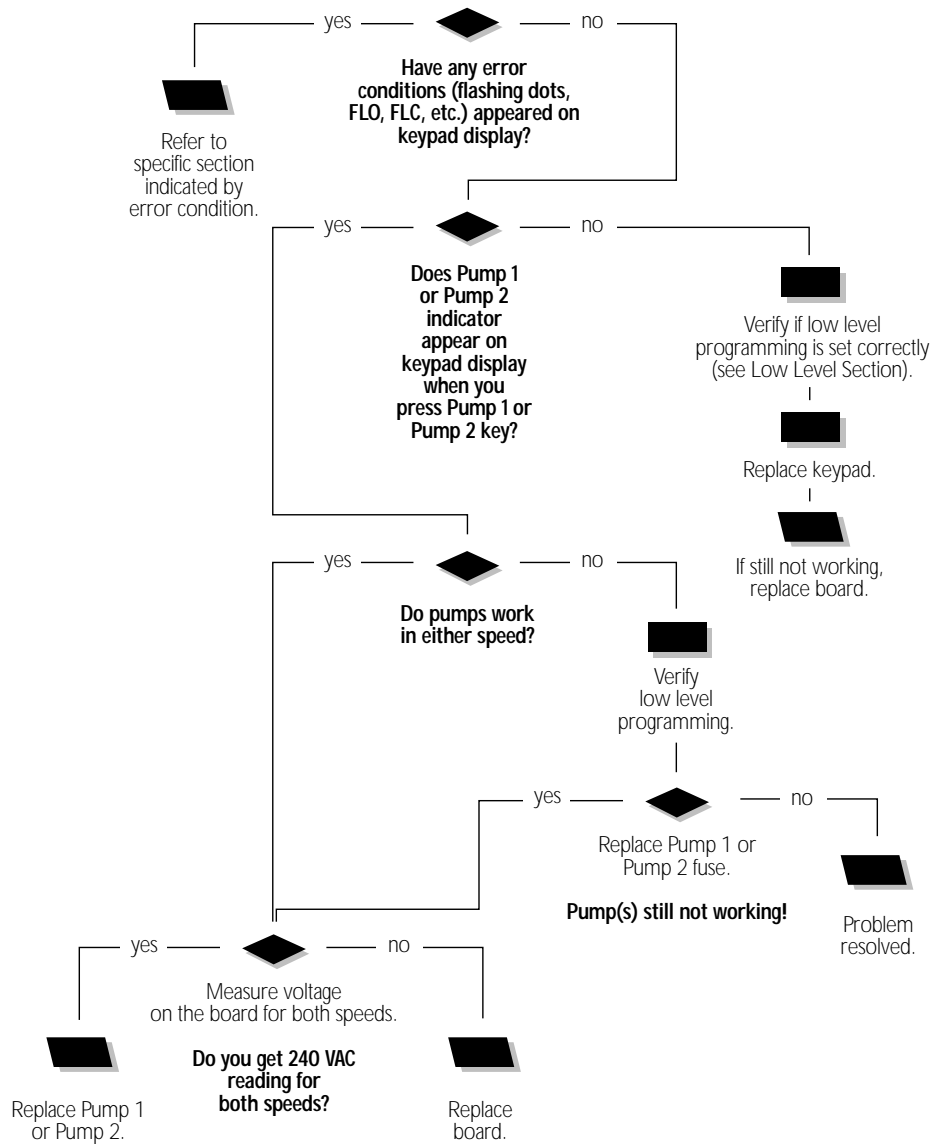



## Pump 1 Does Not Work!

If Pump 1 is not working, carry out the following tests to correct the problem:

To increase the life of the relay, we use a "snubber" circuit on the pump relay. With this type of circuit, if no pump is connected to an output and relays are open, the voltmeter will continue reading around 60 volts. This is normal.

It is important to measure voltage when pump is connected to pack. Power must remain On.



"Pump 1" indicator



- 1• Check for an error condition on keypad display. If yes, refer to specific section indicated by error condition.
- 2• Verify if "Pump 1" indicator appears on keypad display when you press **Pump 1** key.  
If "Pump 1" indicator does not appear, check low level programming first (see Low Level Section).
- 3• If "Pump 1" indicator does not appear, use a spare keypad to verify if keypad is defective.  
If it is, replace keypad.  
If not, replace board.
- 4• If "Pump 1" indicator appears on keypad display when **Pump 1** key is pressed, verify if Pump 1 works in any of the speeds.

## Pump 1 Does Not Work!

If Pump 1 does not work in any speed, carry out the following tests to correct the problem:

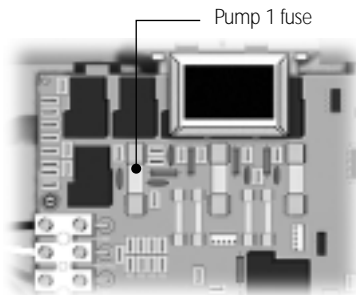

- 1• If Pump 1 does not work in either speed, replace Pump 1 fuse.
- 2• If replacing the fuse does not work, or if Pump 1 works in one of two speeds, take voltage reading on the board for both speeds.

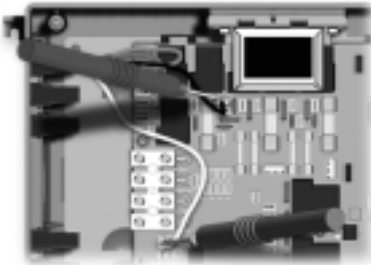

Turn Pump 1 to low speed and measure voltage between white and black wire connectors:  
240 VAC pump: P57 & P64  
120 VAC pump: P48 & P64

The reading should be:  
 $\approx 240$  VAC for a 240 VAC pump  
 $\approx 120$  VAC for a 120 VAC pump

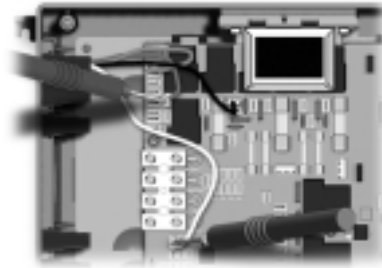

- 3• Turn Pump 1 to high speed and measure voltage between white and red wire connectors:  
240 VAC pump: P57 & P37  
120 VAC pump: P48 & P37

The reading should be:  
 $\approx 240$  VAC for a 240 VAC pump  
 $\approx 120$  VAC for a 120 VAC pump

- 4• If voltage is correct, replace Pump 1.
- 5• If not, replace board.

## Pump 2 Does Not Work!

If Pump 2 is not working, carry out the following tests to correct the problem:

To increase the life of the relay, we use a "snubber" circuit on the pump relay. With this type of circuit, if no pump is connected to an output and relays are open, the voltmeter will get a reading of around 60 volts. This is normal.

It is important to measure voltage when pump is connected to the pack. Power must remain On.



"Pump 2" indicator



- 1 • Check for any error condition on keypad display. If there are, refer to specific section indicated by the error condition.
- 2 • Verify if "Pump 2" indicator appears on keypad display when you press **Pump 2** key.  
If "Pump 2" indicator does not appear, check low level programming first (see Low Level Section).
- 3 • If "Pump 2" indicator does not appear, use a spare keypad to verify if spa keypad is defective.  
If it is, replace keypad.  
If not, replace board.
- 4 • If "Pump 2" indicator appears on the display when you press **Pump 2** key, verify if Pump 2 works in any speed.

## Pump 2 Does Not Work!

If Pump 2 is not working in any speed, carry out the following tests to correct the problem:

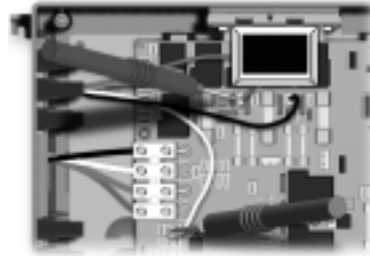
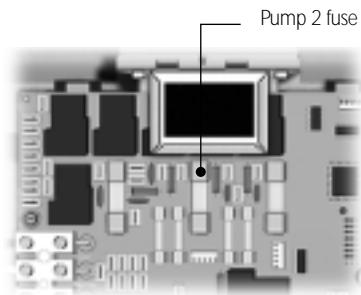

- 1• If Pump 2 does not work in either speed, replace Pump 2 fuse.
- 2• If replacing fuse does not correct problem, or if Pump 2 works in one of two speeds, read voltage on the board for both speeds.

- 3• Turn Pump 2 to high speed and measure voltage between white and red wire connectors:  
240 VAC pump: P58 & P22  
120 VAC pump: P45 & P22

The reading should be:  
≈240 VAC for a 240 VAC pump  
≈120 VAC for a 120 VAC pump

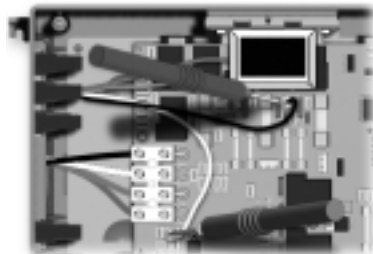

Turn pump 2 to low speed and measure voltage between white and black wire connectors:  
240 VAC pump: P58 & P35  
120 VAC pump: P45 & P35

The reading should be:  
≈240 VAC for a 240 VAC pump  
≈120 VAC for a 120 VAC pump

- 4• If voltage is correct, replace Pump 2.
- 5• If not, replace board.



# Blower Flow Chart

If blower isn't working, follow this Troubleshooting Flow Chart to identify the problem:

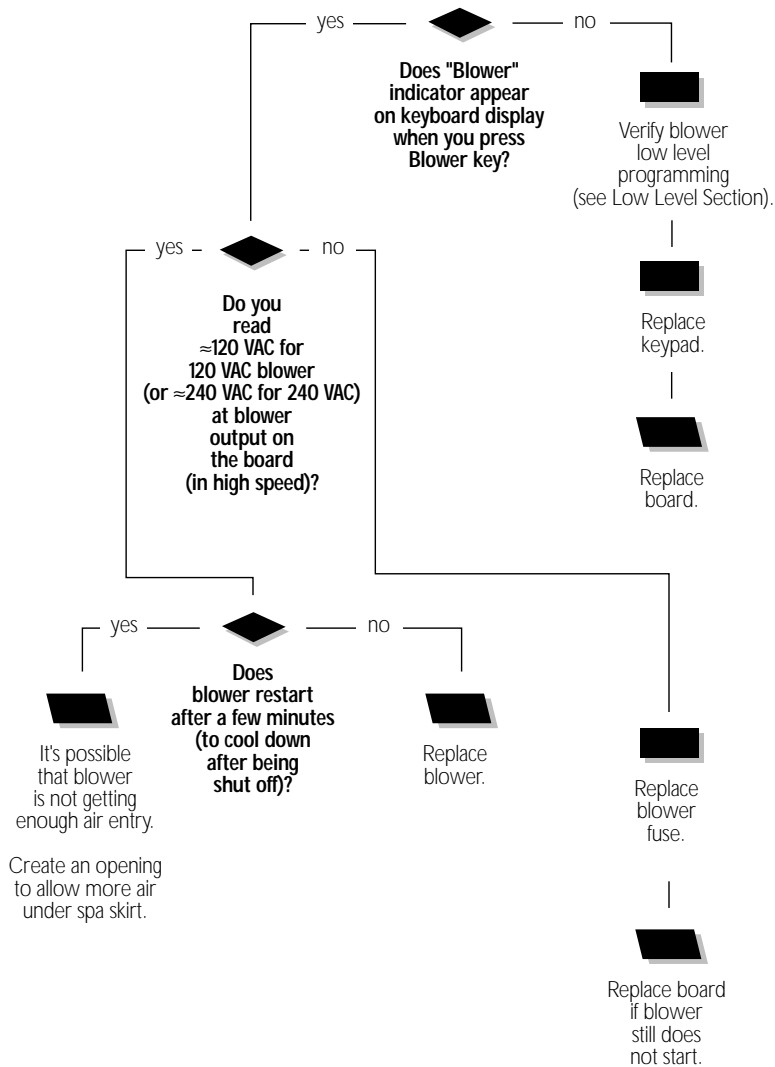

## Blower Does Not Work!

*If blower is not working, carry out the following tests to correct problem:*

To increase the life of the relay, a "snubber" circuit is used on the blower relay. With this type of circuit, if no blower is connected to an output and relays are open, the voltmeter will continue to get a voltage reading of around 60 volts. This is normal.

It is important to measure voltage when the blower is connected to the pack. Power must remain On.

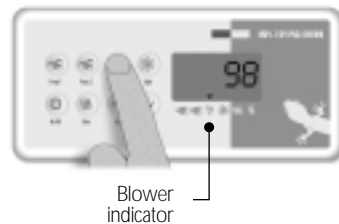

- 1• Verify if "Blower" indicator lights up on keypad display when you press **Blower** key (triangular icon will flash when blower is in low speed).
- 2• Verify if blower low level programming is set correctly.
- 3• If "Blower" indicator does not appear on keypad display, then replace keypad.
- 4• If "Blower" indicator still does not appear on keypad display, then replace board.

## Blower Does Not Work!

If "Blower" indicator lights up on control display, but blower still isn't working, carry out the following tests to correct the problem:

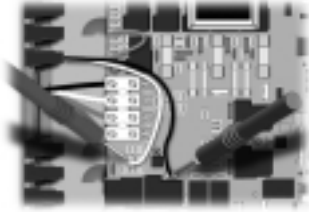

- 1• If indicator lights up on keypad while blower is in high speed, take voltage reading between white and black wire connectors:  
240 VAC blower: P59 & P43  
120 VAC blower: P49 & P43  
  
Your reading should be:  
≈240 VAC for a 240 VAC blower  
≈120 VAC for a 120 VAC blower

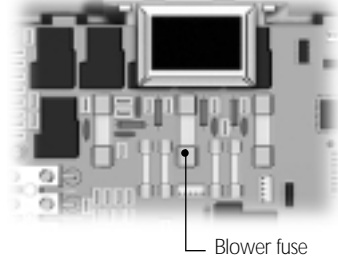

- 2• Replace blower fuse if you do not get a high enough voltage reading.
- 3• Replace board if you still aren't getting a voltage reading. (Refer to "How to Replace the Board" section.)
- 4• If you do get a good voltage reading, check if you can restart blower a few minutes after being turned off.  
  
Replace blower if it does not start after cool down period.
- 5• If blower does start up after cool down, it's possible that it is not drawing in enough air.
- 6• Enlarge the opening to allow more air into blower.





# Spa Light Flow Chart

If spa light does not appear to be working, follow Troubleshooting Flow Chart below to identify the problem:

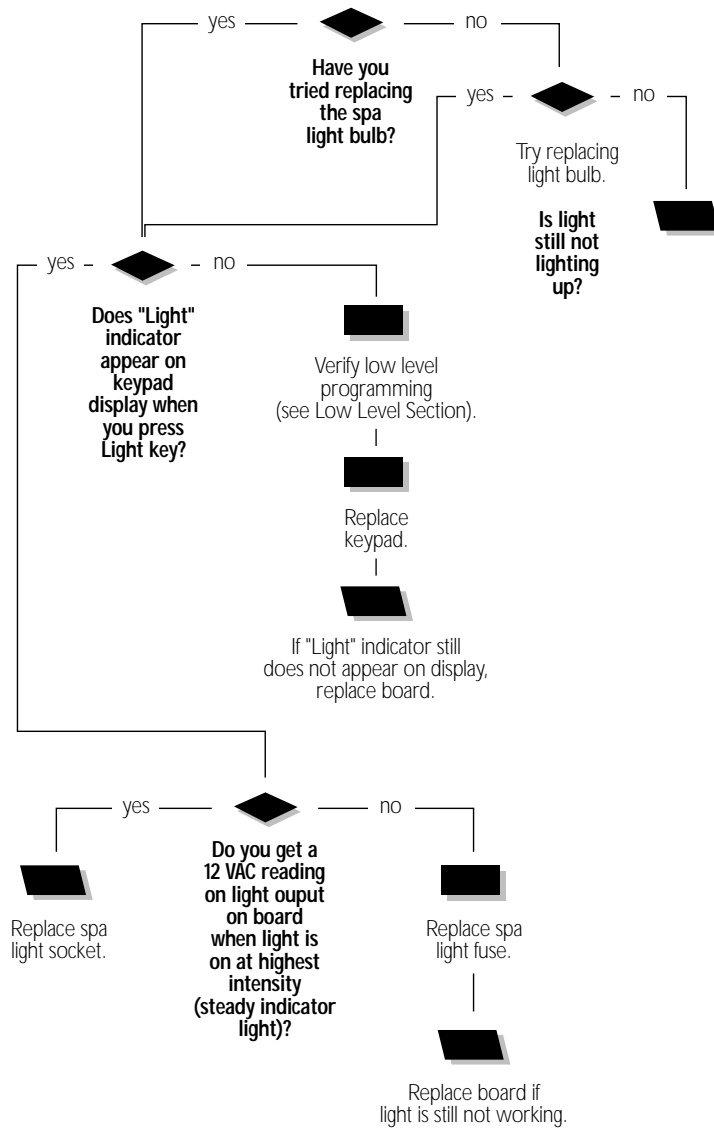

# Spa Light Does Not Work!

If spa light is not working, carry out the following tests to correct the problem:

**It is important to measure voltage when light is connected to the pack. Power must remain On.**

- 1• The first step is to try replacing the spa's light bulb.

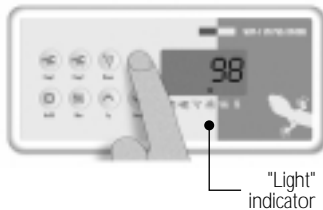

- 2• If light still isn't working, verify if "Light" indicator appears on keypad display when you press **Light** key.



- 3• If "Light" indicator doesn't appear, (verify low level programming first, see Low Level Section) use a spare keypad to verify if spa keypad is defective.

If it is, replace keypad.

If not, replace board.



- 4• If "Light" indicator appears, but light still isn't working, make sure light is at highest intensity setting (indicator solid light, not flashing), remove plastic cover and measure voltage between opposite prongs of connector P14 on the board.

If you get  $\approx 12$  VAC, replace light socket.

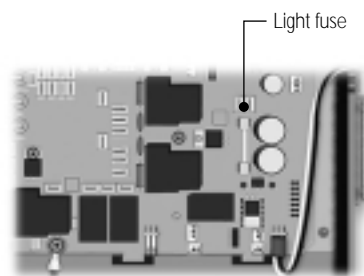

- 5• If you aren't getting a voltage reading, replace light fuse on the board.
- 6• If the problem persists, replace board. (Refer to "How to Replace the Board" section.)

# Ozonator Flow Chart

If the ozonator is not working, follow Troubleshooting Flow Chart below to identify the problem:

If the user turns on a pump, blower or light during a filter cycle, the cycle will be interrupted and will only resume 40 minutes after last active output has been turned off (automatically or manually). This delay is to prevent excessive ozonator activation.

During this interval, "Filter cycle" indicator will flash in a different sequence (On: 1/2 sec., Off: 1/2 sec., On: 1/2 sec., Off: 1 1/2 sec.).

Also, to prevent excessive water temperature caused by overly long filter cycles, the system will cancel a filter cycle after 3 hours if water temperature rises more than 2°F above set point. In this case, "Filter Cycle" indicator flashes on display.

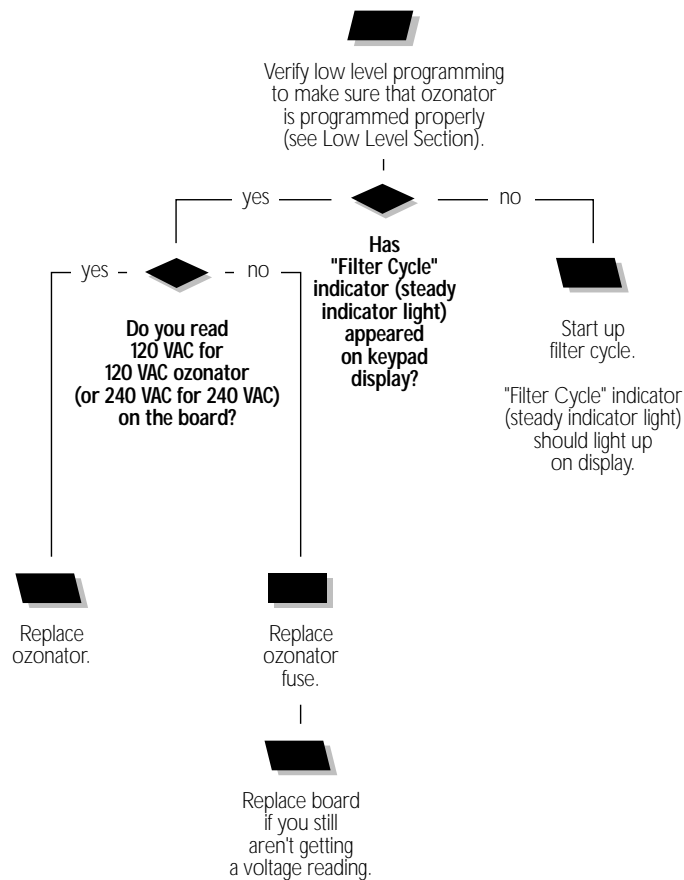

# Ozonator Does Not Work!

*If ozonator isn't working, carry out the following tests to correct the problem:*

**To increase the life of the relay, a "snubber" circuit is used on the ozonator relay. With this type of circuit, if no ozonator is connected to an output and relays are open, the voltmeter will still get a reading of around 60 volts. This is normal.**

**It is important to take voltage reading with ozonator connected to the pack. Power must remain On.**

N.B.: On new systems, if a pump, blower or light is turned on during filter cycle, the cycle will be interrupted and will resume only 40 minutes after the last active output has been turned off. This delay is to prevent excessive ozonator activation.

During this time, "Filter Cycle" indicator will flash in a different sequence (3 short, 1 long, 3 short, 1 long, etc.).

To prevent excessive water temperature due to overly long filter cycles, the system will automatically cancel a filter cycle after 3 hours if water temperature climbs more than 2°F above set point. In this case, "Filter Cycle" indicator flashes on the display.



"Filter Cycle" indicator

- 1• Verify low level programming to make sure that ozonator is programmed properly (see Low Level section).
- 2• Verify if "Filter Cycle" indicator (steady indicator light) appears on keypad.

If not, start up a filter cycle (refer to MSPA-MP User's Manual).

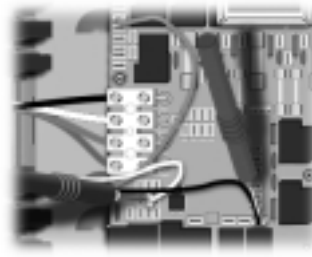

- 3• Measure voltage between ozonator white and black wire connectors:  
240 VAC ozonator: P60& P30  
120 VAC ozonator: P46 & P30

You should read:  
≈240 VAC for a 240 VAC ozonator  
≈120 VAC for a 120 VAC ozonator

- 4• Replace ozonator if you get a good voltage reading.

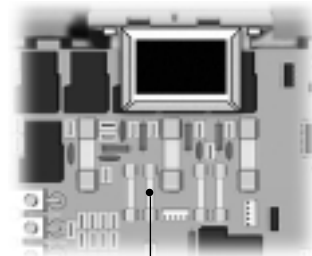

Ozonator fuse

- 5• Replace ozonator fuse if voltage reading isn't high enough.
- 6• Replace board if you still don't get a voltage reading. (Refer to "How to Replace the Board" section.)

# Circulation Pump Flow Chart

If circulation pump does not appear to be working, follow Troubleshooting Flow Chart below to identify the problem:

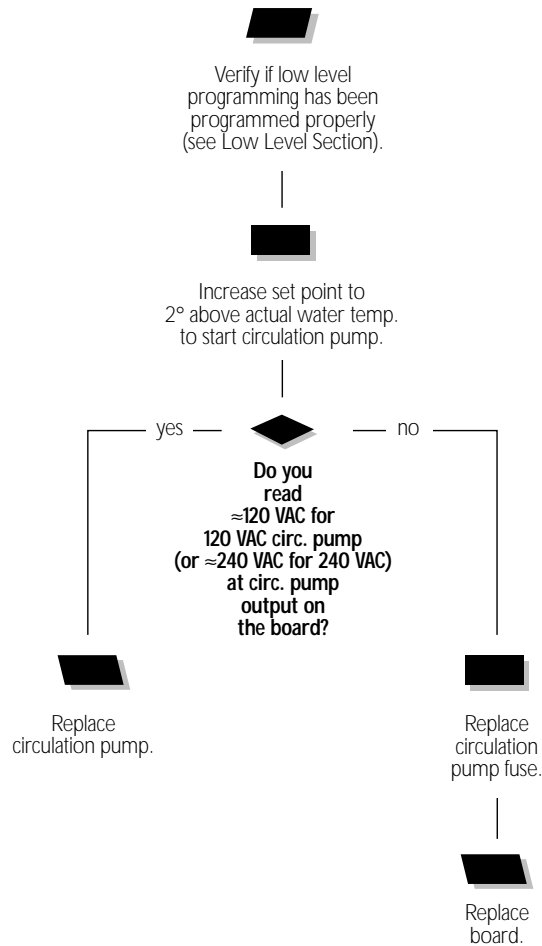

# Circulation Pump Not Working!

If your MSPA-MP has a defective circulation pump, carry out the following tests to correct the problem:

To increase the life of the relay, a "snubber" circuit is used on the circulation pump relay. With this type of circuit, even if no circulation pump is connected to an output and relays are open, the voltmeter will continue to get a volt reading around 60. This is normal.

It is important to take voltage reading when circulation pump is connected to the pack. Power must remain On.



- 1 • Verify if low level programming has been programmed properly (see Low Level Section).
- 2 • Start circulation pump by setting temperature set point 2° higher than actual water temperature.

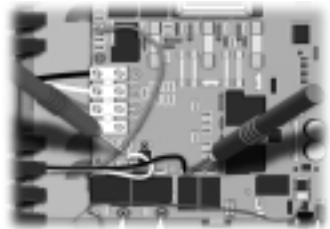

- 3 • Remove plastic cover and take voltage reading between circulation pump's black and white wire connectors.  
240 VAC pump: P36 & P54  
120 VAC pump: P36 & P41

The reading should be:  
≈ 240 VAC for 240 VAC pump  
≈ 120 VAC for 120 VAC pump

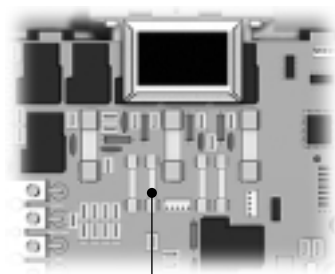

- 4 • If you don't get a voltage reading, replace board's circulation pump fuse.
- 5 • If problem persists, replace the board. (Refer to "How to Replace the Board" section.)

# Keys Flow Chart

*If any of the keys on the keypad display do not seem to be working, follow Troubleshooting Flow Chart below to identify the problem:*

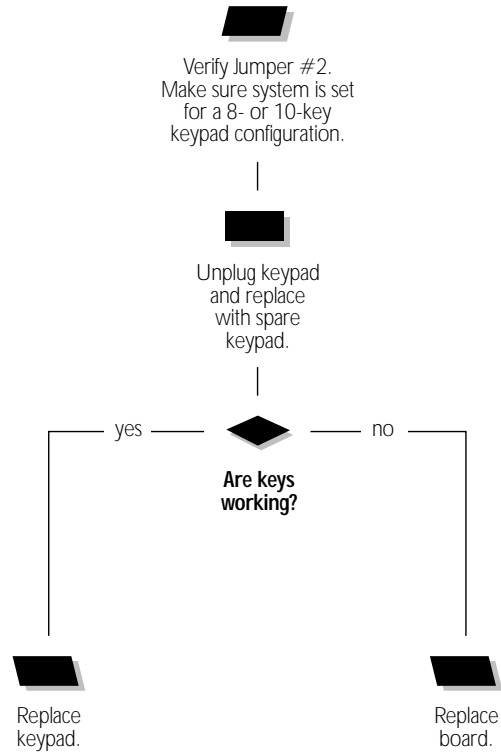



## Keys Aren't Working!

*If any of the keys do not seem to be working, carry out the following tests to correct the problem:*

---



- 1 • Verify Jumper #2. Make sure system is set for a 8- or 10-key keypad configuration.
- 2 • Replace keypad with a spare keypad.
- 3 • Verify if keys respond correctly.
- 4 • If they do, replace keypad.
- 5 • If they do not respond, replace board.

## How To Replace The Board

*When replacing an MSPA-MP board, it is important to make sure to turn power off before proceeding.*



- 1 • Loosen 4 screws holding spa pack cover and remove. Disconnect power input cables.

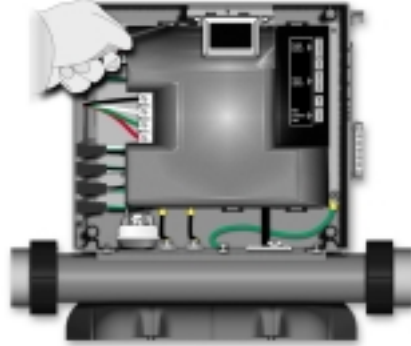

- 3 • Insert the end of a flat screwdriver into the slots at the top of the plastic cover to remove black plastic cover protecting the circuit board.

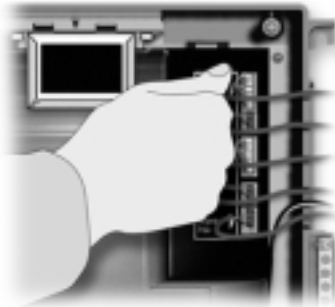

- 2 • Unplug keypad(s) and temperature sensor located in the upper right corner of the power box.

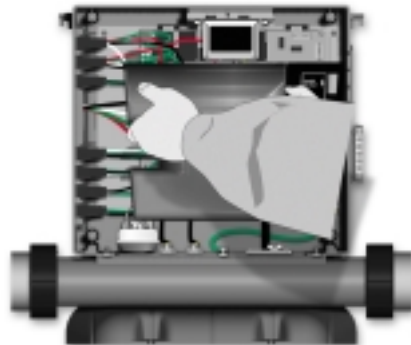

- 4 • Lift up the cover on both sides and remove it from the power box.

## How To Replace The Board

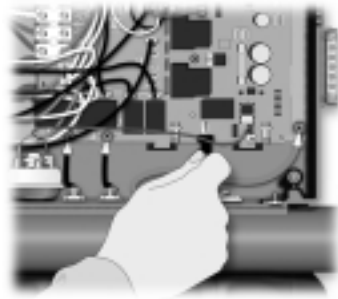

- 5• Disconnect high limit sensor and pressure switch cable.

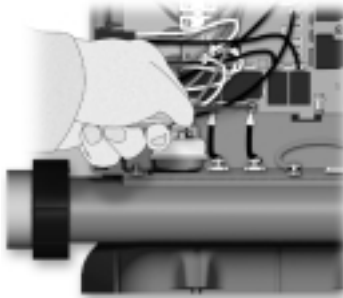

- 6• Disconnect heater output by removing two screws at the bottom of circuit board.

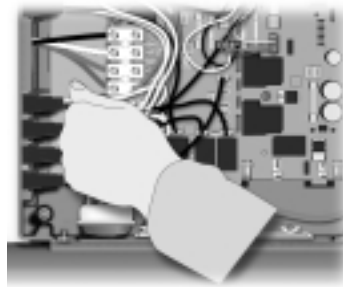

- 7• Unslot AMP or J&J mini connectors from side of the pack.



- 8• The circuit board is supported by a metal plate, with the entire assembly being held in place by 5 screws (one attached to ground wire). Remove screws and disengage the defective board/plate assembly (**Note:** transformer remains attached to board.)
- 9• Correctly align replacement board/metal plate assembly with original screw holes and reattach to board with 5 screws.
- 10• Now, reinsert J&J mini connector to pack side.
- 11• Switch transformer from one plate to the other.
- 12• Re-connect heater cables.
- 13• Re-connect pressure switch and high temperature sensor cables.
- 14• Verify all connections. Reposition plastic cover.
- 15• Re-connect keypad(s) and temperature sensor connections.
- 16• Re-connect power cable and turn power back on.

## How To Replace The Heater

Follow instructions below to replace an MSPA-MP pack heater configured for standard **horizontal/front/bottom position**.

**Note:** Make sure to turn power to the pack off before proceeding.

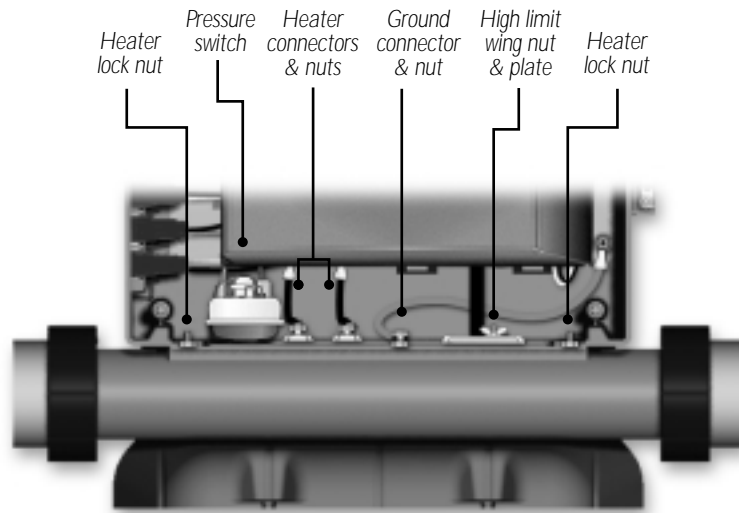

**Important:** Before starting removal procedure be sure to:

- disconnect pack power input cables;
- ensure spa water valves are closed.

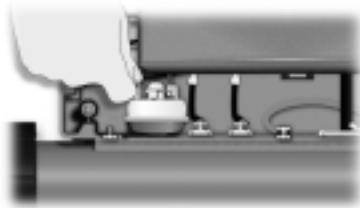

- 1• Use a pair of pliers to disconnect 2 wires (red and green) of cable connected to the top of Teflon pressure switch by pulling upwards (in no particular order).

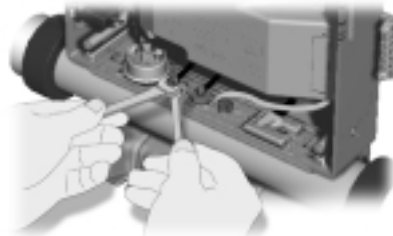

- 2• Using a 1/4" wrench to hold steady and a 3/8" wrench to carefully turn, loosen nuts securing 2 heater connectors to top of blue plastic support plate. Disengage heater wires. Be careful not to damage ceramic by twisting or bending.

## How To Replace The Heater

Instructions to replace MSPA-MP pack heater configured for standard **horizontal/front/bottom** position.

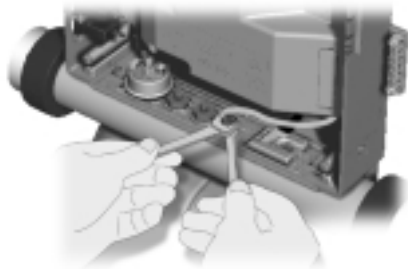

- 3• Use a wrench to loosen the two ground cable nuts (one on top of the other), and disengage ground wire (located immediately to the left of the high limit plate).

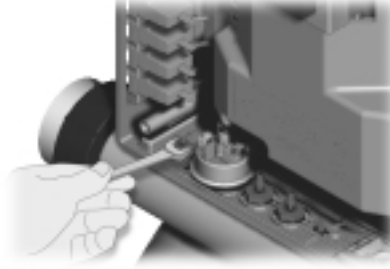

- 5• Remove two remaining nuts at opposite ends of blue plastic heater support plate, thus enabling you to free heater from spa pack.

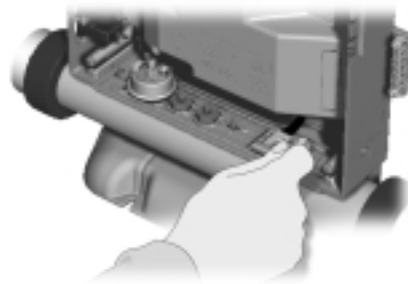

- 4• Unscrew the wing nut holding the high limit plate and release high limit rubber sensor from plate.

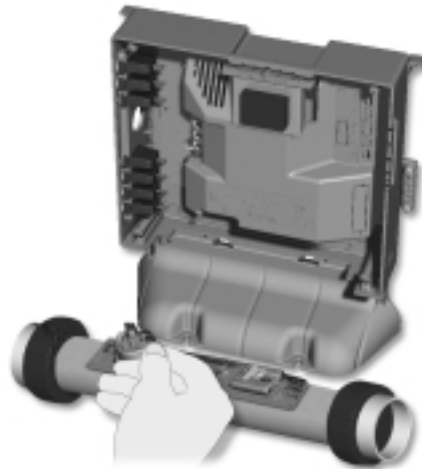

- 6• Remove pressure switch from plastic heater plate by turning counter-clockwise by hand.

# How To Replace The Heater

Instructions to replace MSPA-MP pack heater configured for standard **horizontal/front/bottom** position.

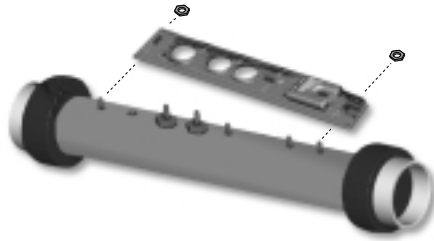

- 7 • Remove two remaining jam nuts from each end of the support plate and remove plate from heater.
- 8 • Finally, replace old heater with new one, and follow same procedure in reverse order to connect replacement heater to spa pack.

## A few helpful hints when reconnecting:

- a) Don't turn wing-nut too tightly, just enough to hold rubber sensor in place.
- b) When reconnecting wires from heater to board, it is important to use two wrenches to hold nuts steady. Any bending or twisting may cause damage to ceramic.

Note: We recommend the use of an adjustable torque wrench (17 lb/in) to screw the top nut sufficiently. For more details, log on to:

[www.metapacks.com/a\\_tn.htm](http://www.metapacks.com/a_tn.htm)  
(Gecko's Tech News #9906)

## How To Replace The Heater

Follow instructions below to replace an MSPA-MP pack heater in the **vertical/side** position.

**Note:** Make sure to turn power to the pack off before proceeding.

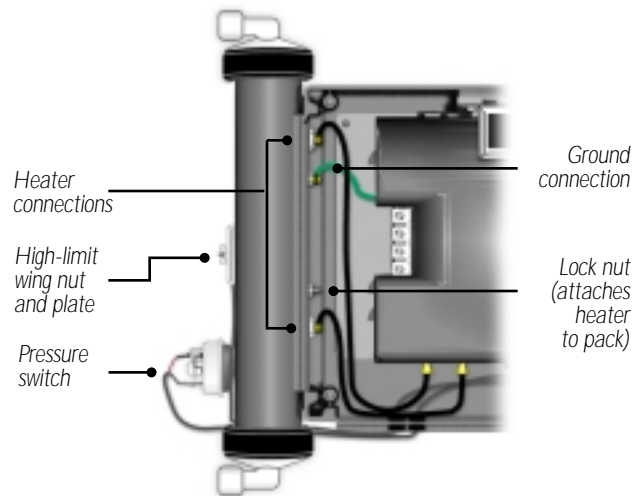

**Important:** Before starting removal procedure be sure to:

- disconnect pack power input cables;
- ensure spa water valves are closed.

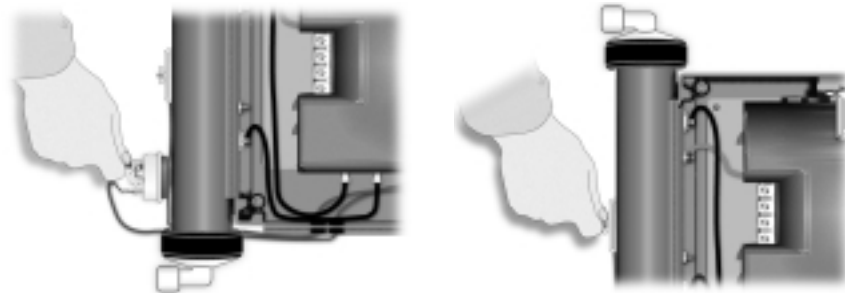

- 1• Use a pair of pliers to disconnect 2 wires (red and green) of cable connected to top of pressure switch attached to the outside edge of the heater (in no particular order).
- 2• Loosen the wing-nut holding the hi-limit plate and probe in place centrally located on the outside of the heater and remove the probe and plate.

Then loosen pressure switch by turning counter-clockwise by hand and remove.

# How To Replace The Heater

Instructions to replace an MSPA-MP pack heater in the **vertical/side** position.



- 3• Use 1/4" wrench to hold steady and 3/8" wrench to loosen nuts to disconnect 2 heater wire connections. Be careful not to damage ceramic by twisting or bending.

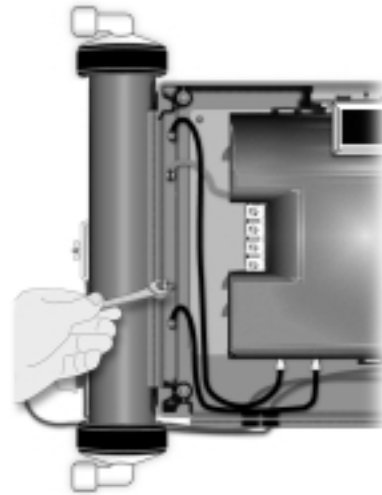

- 5• Remove the last remaining nut retaining the heater and disengage heater from spa pack.
- 6• Replace the defective heater with a new one, and repeat the same procedure in reverse order to reconnect replacement heater to the spa pack.



- 4• Use a wrench to remove the ground cable nut and disconnect the ground cable wire.

#### A few helpful hints when reconnecting:

- a) Don't turn wing-nut too tightly, just enough to hold high temperature sensor in place.
- b) When reconnecting wires from heater to board, it is important to use two wrenches to hold nuts steady. Any bending or twisting may cause damage to ceramic.

Note: We recommend the use of an adjustable torque wrench (17 lb/in) to screw the top nut sufficiently. For more details, log on to:

[www.metapacks.com/a\\_tn.htm](http://www.metapacks.com/a_tn.htm)  
(Gecko's Tech News #9906)



## How To Replace The Heater

Instructions to replace an MSPA-MP pack heater configured for **horizontal/back/bottom position**.

**Note:** Make sure to turn power to the pack off before proceeding.

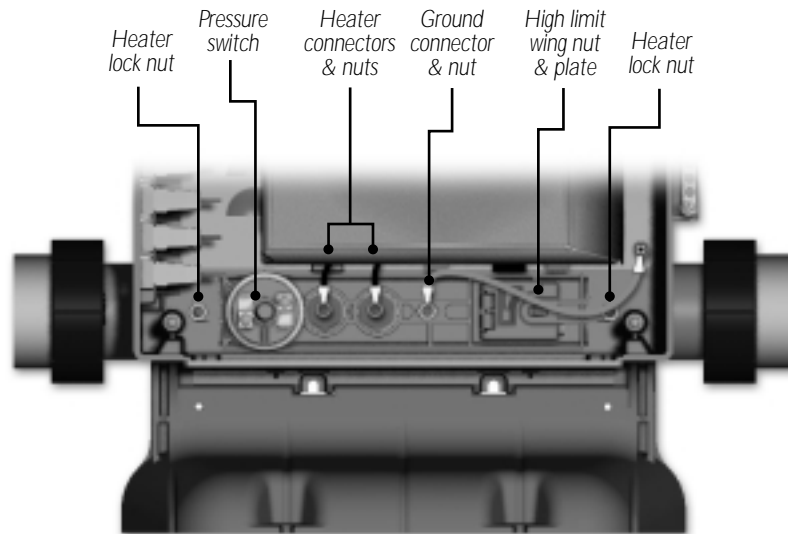

To change the heater on a spa configured for back/horizontal heater position follow the same instructions as for the front/horizontal heater position (shown on previous pages). The main difference is in the position of the blue plastic support plate, which sits on the top of the heater in the front position, but is positioned sideways at the bottom of the pack in the back/horizontal position.



Front/horizontal heater position

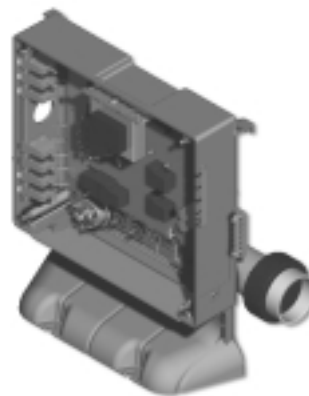

Back/horizontal heater position

## How To Install a Laing Heater

Follow instructions below to install a Laing heater on MSPA-MP metapacks.



- 1• To install a Laing heater on a MSPA-MP metapack, you will need pliers, a Phillips screwdriver, a 11/32" nut driver and a 3/8" open end wrench.



- 4• With the heater plate in position, squeeze the ground cable between 2 nuts (one on top of the other) with a wrench.

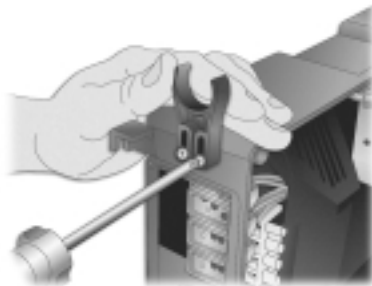

- 2• Install heater top holders on both upper sides of the pack. These holders can be adjusted and should be fixed only after heater has been placed in its final position.

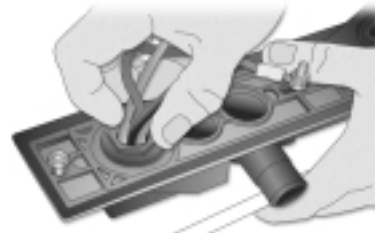

- 5• Hand tight heater cable plastic nut in place.

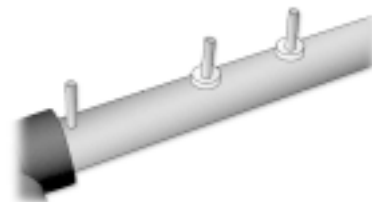

- 3• Slide nylon sleeves into heater threaded studs.



- 6• Do the same with the pressure switch.

## How To Install a Laing Heater



- 7• Snap upper section of heater tube into top holders.



- 10• Push hi-limit rubber sensor in place.

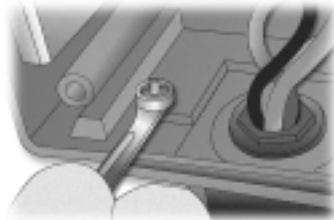

- 8• Tilt bottom part of heater in position.

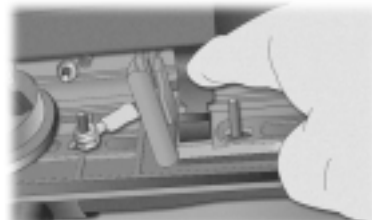

- 11• Tilt down hi-limit plastic latch and screw wing nut.

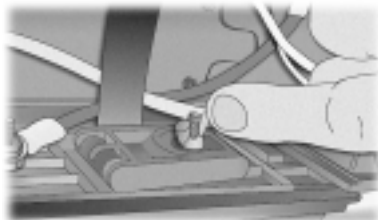

- 9• Screw plate nuts at opposite ends of heater support plate.



- 12• Connect pressure switch cables.

## How To Install a Laing Heater



13• Connect ground cable to board.



15• Adjust top holders in their final position.

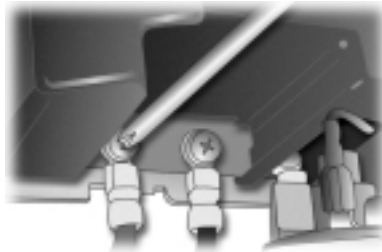

14• Connect heater cables to board.

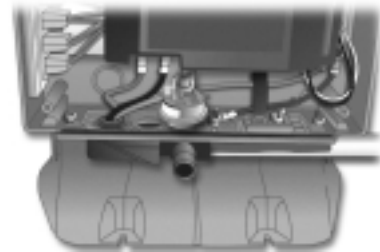

16• Verify heater plate connections and place pack cover.

# How To Adjust The Pressure Switch

## When a voltmeter is available:

- 1 • Set voltmeter to " $\Omega$ " (while both probes are touching one another, voltmeter should beep to show there is continuity).
- 2 • Turn Pump 1 off.
- 3 • Do you have continuity on pressure switch?  
If you have no continuity, go to step 4.

If you do have continuity, increase pressure switch setting by turning clockwise until voltmeter stops beeping. Then, increase another full turn.

- 4 • Turn Pump 1 on at low speed and wait a few minutes.

If (3) flashing dots do not appear, you have adjusted the pressure switch successfully.

If (3) flashing dots appear, decrease pressure switch setting by turning counter clockwise until voltmeter starts beeping (there is continuity). Then, decrease another 1/4 of turn. Turn pump off.

The (3) flashing dots should not appear (restart procedure if (3) flashing dots appear).

- 5 • When adjustment procedure is completed, apply Loctite 425 to the adjustment screw to secure it in place.



## How To Adjust The Pressure Switch



### When a voltmeter is not available:

- 1 • Turn Pump 1 off.
- 2 • Decrease the pressure switch setting to 0.5 P.S.I. or until three flashing dots are displayed.
- 3 • Start increasing pressure switch setting by very slowly turning adjustment screw clockwise until three flashing dots disappear, then another full turn.
- 4 • Turn pump on at low speed for 30 seconds; there should be no flashing dots on display.
- 5 • Turn pump off and wait 30 seconds. You should not see the three flashing dots.
- 6 • If you see an error, restart the adjustment procedure.

If you are not able to adjust the pressure switch, change it.

# Parts List

We recommend that field service technicians keep the items identified with an \* in stock.

Ref.:	Part Number	Description	Suggested Retail U.S.	CDN
1	530AB0061	Tail piece for 2" heater	5.39	7.33
2	530AB0042-P5	Gasket for 2" tail piece (package of 5)	8.00	10.88
3	530AB0055	Nut for 2" heater	4.90	6.67 *
4	9920-400497	Light cords for MSPA-MP (option LS)	7.57	10.30 *
4	9920-400489	Dual light cord for MSPA-MP (option L2S)	17.83	24.96
5	140AA0125-P10	Blank plate for output connector hole (package of 10)	10.89	14.82
6	9920-400200	J&J mini connector for pump 1	7.26	9.88
6	9920-400199	J&J mini connector for pump 2, single speed	6.68	9.09
6	9920-400200	J&J mini connector for pump 2, two speeds	7.26	9.88
6	9920-400204	J&J mini connector for ozone	5.92	8.06
6	9920-400203	J&J mini connector for blower	5.92	8.06
6	9920-400205	J&J mini connector for circulation pump	5.92	8.06
6	9920-400211	AMP connector for pump 1	7.26	9.88
6	9920-400212	AMP connector for pump 2, single speed	6.68	9.09
6	9920-400213	AMP connector for pump 2, two speeds	7.26	9.88
6	9920-400206	AMP connector for ozone	6.68	9.09
6	9920-400208	AMP connector for blower	6.68	9.09
6	9920-400207	AMP connector for circulation pump	6.68	9.09
6	9920-400209	AMP connector for light	5.34	7.27
7	282AC0138-P25	Screws for the transformer (package of 25)	7.57	10.30
8	282BA0036	Screws for the metal plate	7.57	10.30
9	282AD0101	Ground screws for the metal plate	7.57	10.30
10	9920-400435	Cable hi-limit for vertical heater MSPA-MP 30"	10.17	14.24
11	9920-400123	Heater cable 3"	1.71	2.40
11	9920-400341	Heater cable (vertical) 9"	2.57	3.60
11	9920-400348	Heater cable (vertical) 15"	3.49	4.88
12	530AA0012	In-line 5.5Kw heater	143.17	194.79
13	530AB0087	5.5Kw 240V element for in-line heater	88.20	119.99 *
14	510AD0064	Pressure switch	28.42	38.67 *
15	9920-400124-P5	Pressure switch cable for in-line heater (package 5)	11.80	16.06 *
16	9920-100153	120 volts transformer for MSPA-MP	62.23	87.12 *
16	9920-100152	240 volts transformer for MSPA-MP (option T2)	64.51	90.32 *
	430AC0054-P10	Fuses for circulation pump (package of 10)	10.69	14.55 *
	430AC0054-P10	Fuses for ozone (package of 10)	10.69	14.55 *
	282AD0072-P25	Screws for the heater cable (package of 25)	8.80	11.97
	430AC0069-P10	Fuses for blower (package of 10)	17.82	24.24 *
	430AC0117-P10	Fuses for light (package of 10)	11.14	15.15 *
	430AE0027-P10	Fuses for pump 1 (package of 10)	56.57	76.97 *

Prices subject to change without prior notice.

# Parts List

We recommend that field service technicians keep the items identified with an \* in stock.

Ref.:	Part Number	Description	Suggested Retail U.S.	CDN
17	430AC0092-P10	Assembly board & plate MSPA-MP (cable included)	531.77	744.48
	9917-100169	Fuses for the transformer (package of 10)	11.14	15.15
18	9917-100169	Plastic cover for MSPA-MP	22.94	31.21
19	9917-100424	Plastic cover power module MSPA-MP	28.00	39.20
20	9920-400262	10-foot temperature probe for MSPA-MP & SSPA	19.20	26.12 *
21	210AB0358-P10	Plastic jumper	0.06	0.10
22	282AD0072-P10	Screws for the heater connection	3.60	5.04
23	9917-100425	Bracket for heater 2-1/4" MSPA-MP	3.60	5.04
24	9917-100426	Hi-limit for MSPA-MP	3.60	5.04

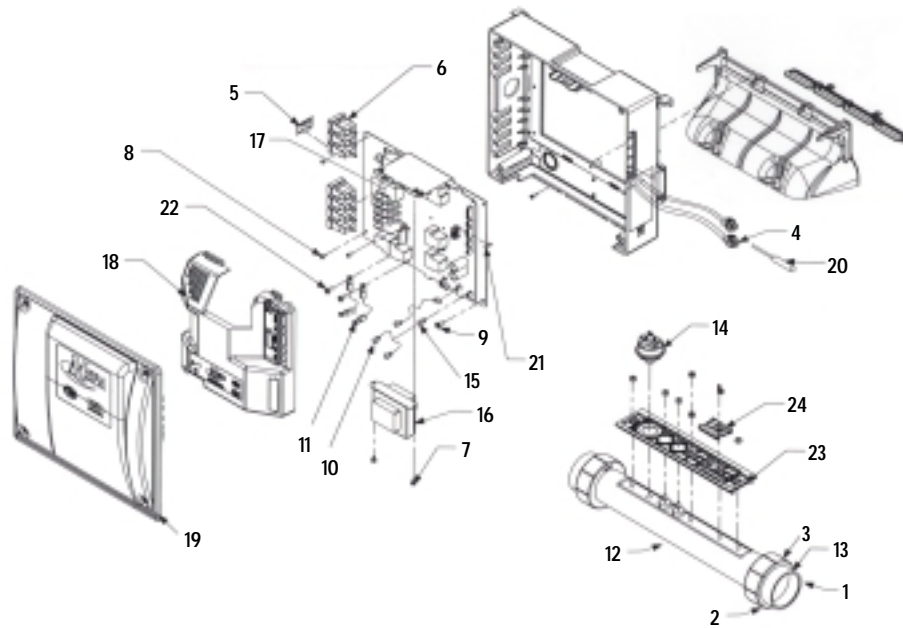

Prices subject to change without prior notice.



# Wiring Diagram (Horizontal)

The wiring diagram below provides a general idea of MSPA-MP wiring, but it is important to note that it may not apply to all systems. The wiring diagram including on inside power box cover is the one to be used as main reference for the spa you are servicing.

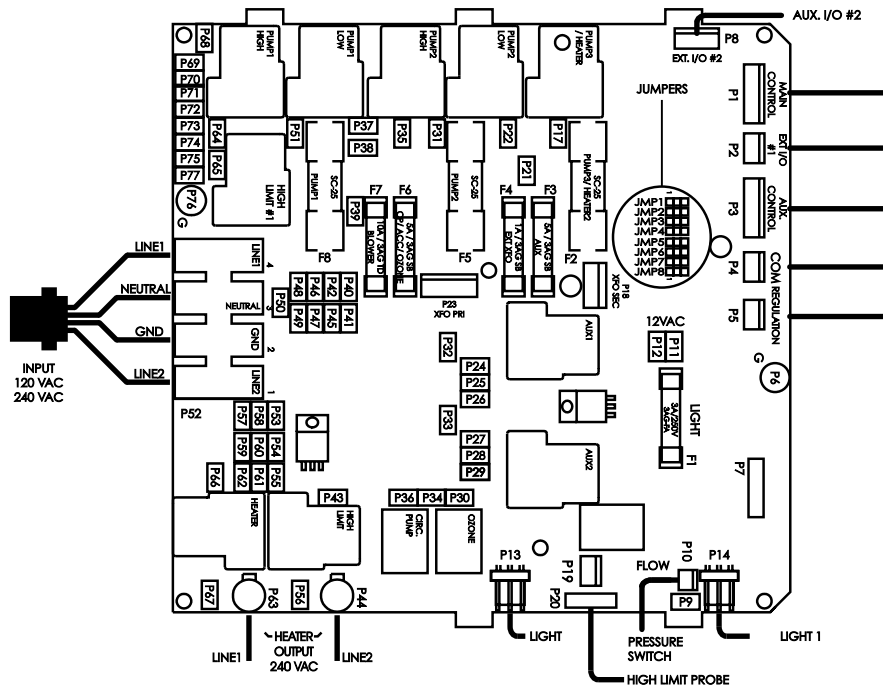

Pump 1		
Voltage	120 v	240 v
Green / Ground	P69	P69
Red / Low Speed	P37	P37
Black / High Speed	P64	P64
White / Com	P48	P57

Blower		
Voltage	120 v	240 v
Green / Ground	P72	P72
Black / High Speed	P43	P43
White / Com	P49	P49

Circulation Pump		
Voltage	120 v	240 v
Green / Ground	P74	P74
Black / High Speed	P36	P36
White / Com	P41	P54

Pump 2		
Voltage	120 v	240 v
Green / Ground	P70	P70
Red / Low Speed	P22	P22
Black / High Speed	P35	P35
White / Com	P45	P58

Ozone		
Voltage	120 v	240 v
Green / Ground	P73	P73
Black / High Speed	P30	P30
White / Com	P46	P60

Light Connector		
Light 1		P14
Light 2		P13

Heater		
Black 1		P63
Black 2		P44
Green / Ground		Ground

**Jumper Settings**  
Refer to page 8

# Wiring Diagram (Vertical)

The wiring diagram below provides a general idea of MSPA-MP wiring, but it is important to note that it may not apply to all systems. The wiring diagram including on inside power box cover is the one to be used as main reference for the spa you are servicing.

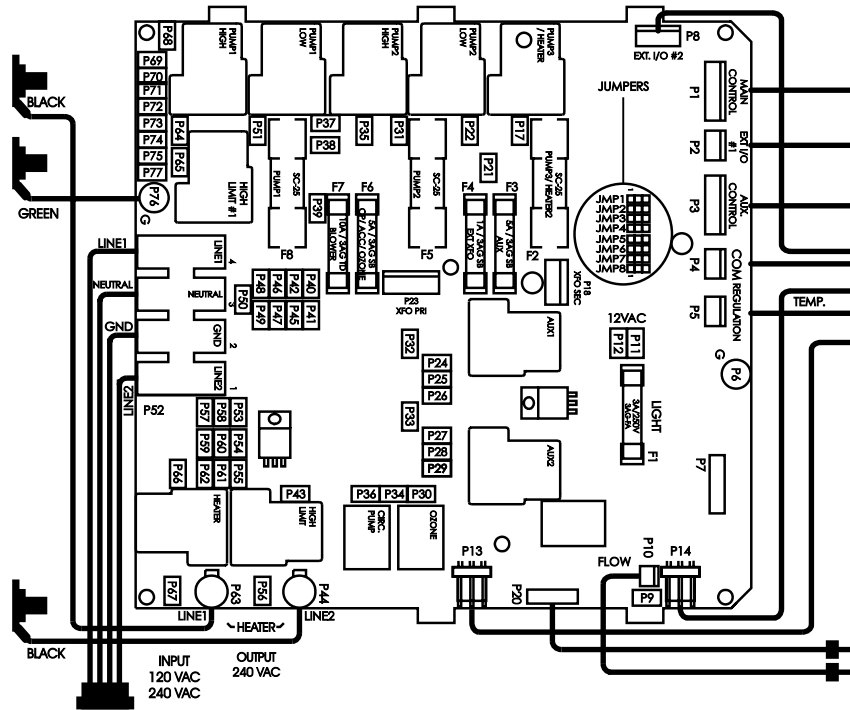

Pump 1		
Voltage	120 v	240 v
Green / Ground	P69	P69
Red / Low Speed	P37	P37
Black / High Speed	P64	P64
White / Com	P48	P57

Blower		
Voltage	120 v	240 v
Green / Ground	P72	P72
Black / High Speed	P43	P43
White / Com	P49	P59

Circulation Pump		
Voltage	120 v	240 v
Green / Ground	P74	P74
Black / High Speed	P36	P36
White / Com	P41	P54

Pump 2		
Voltage	120 v	240 v
Green / Ground	P70	P70
Red / Low Speed	P22	P22
Black / High Speed	P35	P35
White / Com	P45	P58

Ozone		
Voltage	120 v	240 v
Green / Ground	P73	P73
Black / High Speed	P30	P30
White / Com	P46	P60

Heater		
Black 1		P63
Black 2		P44
Green / Ground		Ground

Pump 3		
Voltage	120 v	240 v
Green / Ground	P71	P71
Black / High Speed	P21	P21
White / Com	P40	P53

Jumper Settings		
Refer to page 8		

Light Connector		
Light 1		P14
Light 2		P13



# Professional Repair Kit

All you need in one case!



Gecko's professional repair kit contains all you need to service and repair Gecko's line of Metapacks.

- Top side controls (keypads)
- Temperature probes
- Pressure switch cables
- Flow switches
- Elements
- Heater wires
- Transformer
- Ground lugs
- Grommets
- Standoffs
- Light cords
- Strain reliefs for light cord
- Plugs
- Fuse kits
- Screws



Call 1.800.78.GECKO  
to order or for more info!

# MSPA-MP SERVICE MANUAL



J&J or AMP connectors



Transformer



Keypad & probe connectors

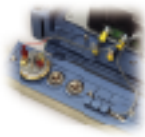

Heater cover plate



Mounting base

**COMPLETE SERVICE GUIDE WITH  
STEP-BY-STEP INSTRUCTIONS ON:**

**GFCI Troubleshooting**

•  
**Jumper Selection**

•  
**Understanding  
& Correcting  
Error Conditions**

•  
**System Malfunctions**

•  
**Part Replacement  
Instructions**

•  
**& More**

